

**MICROPROCESSOR-BASED WATER
TREATMENT CONTROLLER**

MCT200 SERIES

MODELS MCT210, MCT220, & MCT230

**INSTALLATION
OPERATION
MAINTENANCE
INSTRUCTION**

FACTORY SERVICE POLICY

Your controller is a state of the art microprocessor based unit with on-board diagnostics. If you are experiencing a problem with your controller, first consult the troubleshooting guide in your operation and maintenance manual. If the problem is not covered or cannot be solved, please contact our Technical Services Department for further assistance.

Trained technicians are available to diagnose your problem and arrange a solution. Solutions may include purchase of replacement parts or returning unit to the factory for inspection and repair. All returns require a Return Authorization number to be issued by the manufacturer. Parts purchased to correct a warranty issue may be credited after an examination of original parts by the manufacturer. Warranty parts returned as defective which test good will be sent back freight collect. No credit will be issued on any replacement electronic parts.

Any modifications or out-of-warranty repairs will be subject to bench fees and costs associated with replacement parts.

WARRANTY

The manufacturer warrants control systems of its manufacture to be free of defects in material or workmanship. Liability under this policy extends for 24 months from date of shipment. The manufacturer's liability is limited to repair or replacement of any failed equipment or part which is proven defective in material or workmanship upon manufacturer's examination. This warranty does not include removal or installation costs and in no event shall the manufacturer's liability exceed the selling price of such equipment or part.

The manufacturer disclaims all liability for damage to its products through improper installation, maintenance, use, or attempts to operate such products beyond their functional capacity, intentionally or otherwise, or any unauthorized repair. The manufacturer is not responsible for consequential or other damages, injuries, or expense incurred through the use of its products.

The above warranty is in lieu of any other warranty, whether expressed or implied. The manufacturer makes no warranty of fitness or merchantability. No agent of ours is authorized to provide any warranty other than the above.

Note: Conductivity, pH, and ORP sensors are not covered under the warranty. These items carry their own manufacturer's warranty.

FCC WARNING

This equipment generates and uses radio frequency energy. If not installed and used properly, in strict accordance with the manufacturer's instructions, it may cause interference to radio communications. Operation of this equipment in a residential area is likely to cause interference in which case the user, at his own expense, will be required to take whatever measures necessary to correct the interference.

Contents

1. INTRODUCTION	4
Product description	4
2. INSTALLATION	5
Location	5
Installation Notes	5
Sensor Installation	6
Accessories	7
Electrical Wiring	7
3. START UP INSTRUCTIONS	9
Initialization	9
Front Panel	9
Menu Structure	10
Keypad Operation	10
Sample Programming	11
4. CONTROLLER SET-UP	13
General Information	13
System Configure	13
Day Week Date Time	13
Security Access Code	13
Hi Lo Alarm	13
Display Dampener	14
Control Set Point	14
Scale/Range	14
Selectable Inhibitor Timer	15
Totalizer	15
Analog Output Calibration and Settings	15
Alarm Relay	17
Version Number	17
Set Points and Alarms	17
Rising or Falling Set Point	17
High or Low Alarm Settings	17
Set Point Differential	18
Limit Timer	18
Selectable Inhibitor Timer	18
Biocide Programs	20
5. SENSOR INFORMATION/CALIBRATION	22
Conductivity Calibration	22
pH Calibration	23
ORP Calibration	24
6. DIAGRAMS: INSTALLATION, COMPONENT, AND ELECTRICAL	26
7. SPECIFICATIONS	39
8. FACTORY DEFAULT VALUES	41
9. TROUBLESHOOTING	42
10. MAINTENANCE	48
11. GLOSSARY	50
12. ADDITIONAL CALIBRATION TECHNIQUES	52
13. MAKE-UP CONDUCTIVITY	54
14. BIOCIDES PROGRAMMING WORKSHEET	55
15. CONDUIT WIRING TABLE	56

1. INTRODUCTION

These microprocessor based controllers have been designed to control and monitor a wide range of parameters, both analog and digital.

This instruction manual covers the Standard Series of controllers listed in Table 1 along with their standard features. All standard features are covered in this manual and most options have instructions where applicable.

IMPORTANT! While using this manual, if you see instructions for a feature that does not display on your controller, check the following:

- Consult Table 1 to see if that feature is available for your controller either as standard or option.
- Refer to the model number of your controller found on the enclosure of the unit. The letters after the model number are the options installed.
- After the above steps, if feature does not display, reinitialize the unit. If that fails, consult the factory.

For your convenience, there is an abbreviated instruction and software “MENU MAP” laminated card supplied with all manuals to be kept with the controller. This card is not a substitute for this instruction manual. It is supplied as a quick reference only and should be used in conjunction with the instruction manual.

DESCRIPTION

The Conductivity and Conductivity/pH controllers are designed to monitor and control Total Dissolved Solids (TDS) in open recirculating cooling systems, in terms of electrical conductivity measured in micro Siemens ($\mu\text{S}/\text{cm}$). A set point of the desired conductivity limit is entered into the controller through the front keypad. As this maximum limit is exceeded, a blowdown valve is opened. The system water with higher levels of TDS is blown down resulting in fresh make-up water being added, reducing the concentration of TDS in the cooling system.

The pH and Conductivity/pH controllers monitor and control pH by adding acid (or caustic) based on a set point entered into the controller through the front keypad. The set point has a built in limit timer that acts as a fail safe to prevent system overfeed. The design also includes a High/Low Conductivity/pH Alarm. The alarms can be operated in one of two modes: Track Set Point, in which an alarm offset is entered and the alarms automatically adjust themselves around the set point or Independently Set, which allows you to independently set both the High and Low Alarms.

The design also incorporates a Selectable Inhibitor Feed Timer (Option C) which allows the user to choose 1 of 4 timer modes on which to base the addition of inhibitor.

1. “LIMIT TIMER” The Inhibitor Timer is actuated simultaneously with blowdown. The timer limits feed time during any single blowdown cycle, preventing overfeed.
2. “PERCENT TIMER” The Inhibitor Timer runs continuously for

an adjustable time cycle, with output being activated for an adjustable percent of the time cycle.

3. “PERCENT POST BLOWDOWN” This mode keeps track of the total blowdown time and activates the Inhibitor Timer when the blowdown deactivates, for a percent of total blowdown time set.
4. “PULSE TIMER” With Accumulator and Totalizer. The controller accepts pulses from a contact head water meter located in the make-up line and/or blowdown line of the cooling system, to activate the Inhibitor Timer for an adjustable amount of time based on the amount of pulses received.

A mounted flow assembly with quick release sensor, flow switch and sample cock is provided with two of the Standard controllers, refer to Table 1, for the ease and convenience of installation and to facilitate periodic maintenance and sampling. The flow switch disables the outputs of the controller when flow is discontinued in the flow assembly.

A self charging capacitor is used to maintain time and history for up to two weeks. The EEPROM protects operating parameters during power outages. Hand/Off/Auto keys are provided on the keypad for immediate control of pumps, solenoid valves, etc., without scrolling through menus.

These controllers also allow the user to choose a rising or falling set point. The controller accepts options such as ORP, make-up conductivity, biocide timers, and/or communications.

TABLE 1

STANDARD FEATURES

Conductivity	pH	Conductivity/pH
Conductivity	pH Control	Conductivity
Hi/Lo Alarm Indicator	Hi/Lo Alarm Indicator	pH Control
	Limit Timer (pH)	Hi/Lo Alarm (pH)
	Flow Assembly	Hi/Lo Alarm (cond)
		Selectable Timer
		Limit Timer (pH)
		Flow Assembly



!!WARNING!!
CONTROLLER COULD
BE DAMAGED AND
VOID WARRANTY!

Avoid locations where the controller would be subjected to extreme cold or heat [less than 0°F (-17.8°C) or greater than 125°F (52°C)], direct sunlight, vibration, vapors, liquid spills or EMI (electromagnetic interference; i.e., strong radio transmission and electric motors).

2. INSTALLATION

LOCATION

Select a mounting location convenient to grounded electrical and plumbing connections. Mount the controller on a wall or other vertical surface with adequate lighting. Position so operator has access to the unit and a clear view of front panel display. Refer to Diagram 1, pg. 26, Standard Enclosure Dimensional Data and Mounting Hole Template for mounting details of our standard enclosures. Avoid locations where the controller would be subjected to extreme cold or heat. Note Warning at left. Installation should comply with national, state, and local codes.

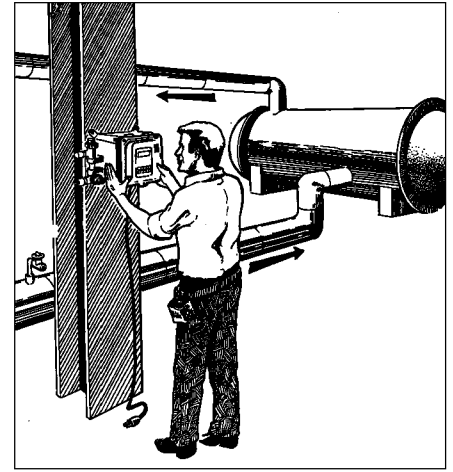

NOTE: NOT ALL EQUIPMENT SHOWN IS PROVIDED WITH THE CONTROLLER AND IS FOR REFERENCE ONLY.

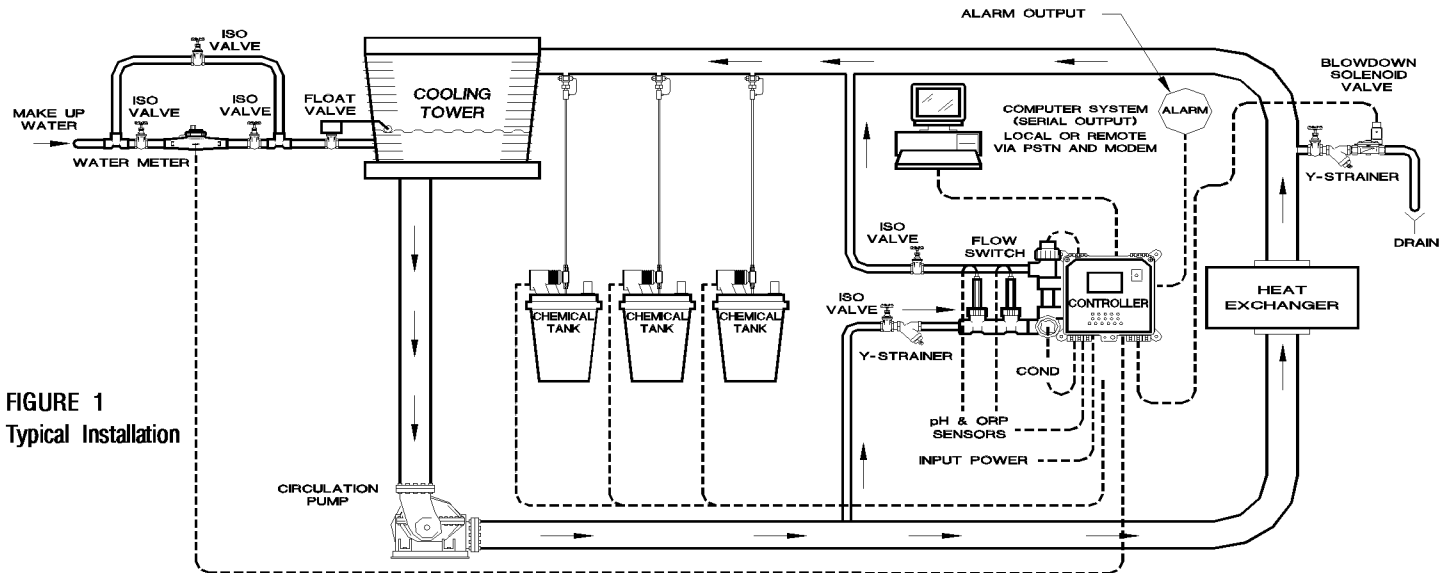

FIGURE 1
Typical Installation



NOTE:

The standard flow assembly, if provided with this controller, is constructed of durable glass filled polypropylene (GFPPL). Standard connection to flow line is 3/4" NPT. A PVC thread to slip adapter is provided so that a PVC weld joint, if preferred, can be made.

INSTALLATION NOTES

1. Install sensors or sample stream flow assembly at some point before chemical injection points, where chemical and water are thoroughly mixed. Refer to Figure 1.
2. Measuring surfaces of the sensors must be continuously immersed in system water.
3. The difference between inlet and outlet pressure must be sufficient to provide a flow rate of 1 GPM (3.8 l/m).
4. Install strainer on the upstream side of the flow assembly to collect debris that might affect controller operation. Install unions on both inlet and outlet.
5. Install hand valves on each side of the flow assembly for easy isolation and removal of sensors and strainer screens (see Fig. 1).
6. Direction of flow should be from the bottom to the top of the flow assembly (see Fig. 2).

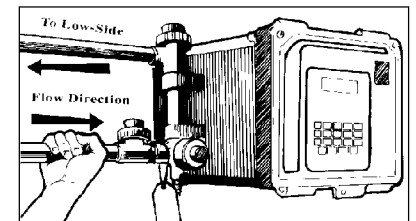

FIGURE 2

Hand tighten all NPT connections until snug plus 1/2 turn.

Note that a pressure differential must exist between the High and Low side for proper flow.



NOTE:

A horizontal length equivalent to at least 12 pipe diameters must precede the water meter inlet and a horizontal pipe length of 6 diameters must follow it. All piping in this area must be of the same diameter.



!!WARNING!!

Care should be exercised when removing the protective cover from the pH sensor. Save for future storage. Care should also be taken to prevent the glass bulb from hitting the tee or other piping. Never expose the sensor to air with power on for more than 45 seconds. Never allow the sensor to dry out. Use supplied rubber boot filled with proper storage solution. See Section 10, pg. 46 Maintenance for more information.

7. A manual valve should be installed in the blowdown line on the system side of the solenoid valve. This will be used for isolating and throttling (controlling the flow rate of blowdown) blowdown assembly if blowdown is incorporated.

8. Most solenoid valves require a pressure differential of 7 to 15 psi to close. If this is not available, install zero pressure solenoid valve, if blowdown is incorporated.

9. Always install a strainer upstream of the solenoid valve to collect debris that may clog solenoid valve if blowdown is incorporated.

10. For proper operation and accuracy, install water meters horizontally with meter face up if Pulse Timer mode is used.

11. If chemicals are to be injected into a sample line (not recommended) always use a back check valve to prevent chemicals from backing up around the sensor.

12. If a flow assembly or sample stream assembly is present, never install blowdown valve off these lines. System will not achieve proper blowdown and accuracy of controller readings may be affected.

13. Install sensors as shown in Figures 3-7 at right. After installation of sensors, open isolation valves to check for leaks.

SENSOR INSTALLATION

Controller should be per installation diagram (see Figure 1). Make sure all fittings and connections are secure:

1. Remove power from the controller.
2. Close isolation hand valves located before and after the flow assembly.
3. Open the sample port on flow assembly to make sure no flow is present in the flow assembly.
4. Remove coupling nut(s) from sensor housings on flow assembly. Then remove threaded insert(s) by gently pulling straight out (Figure 3). Insert is held in place by rubber "O" ring.
5. Apply six wraps of teflon tape to threads of sensors (Figure 4).
6. Slip coupling ring over sensor, then hand tighten threaded insert on the teflon wrapped threads of sensor. (Figure 5)
7. If your controller is equipped with a pH or ORP sensor, remove the liquid filled protective cover from the sensor tip. **IMPORTANT! Do not allow the sensor's tip to dry out, see Warning at left! (Figure 6)**
8. Gently install sensor into sensor housing on flow assembly. Make sure sensor is firmly seated in housing. (Figure 7)
9. Slip coupling ring down onto housing threads and hand tighten.
10. Make sure sample port on flow assembly is closed and apply pressure and flow by opening hand valves slowly to avoid water hammer.

Refer to Diagrams 2, 2a, 3, and 3a, pgs. 27-29, for information and specifications for sensors supplied with your system.

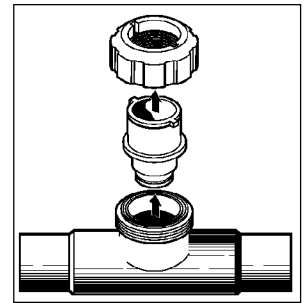

FIGURE 3

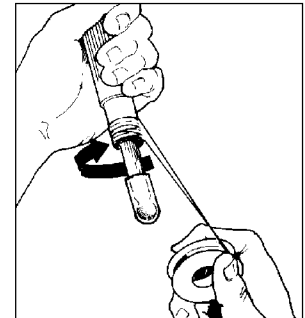

FIGURE 4

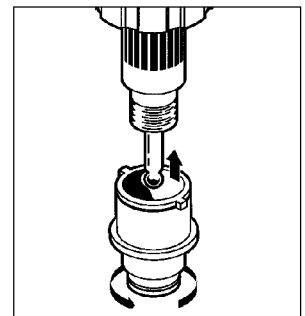

FIGURE 5

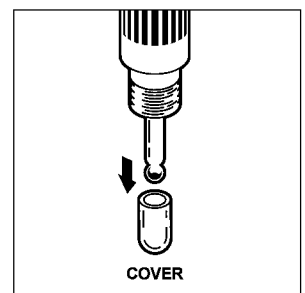

FIGURE 6
IMPORTANT! Do not allow the sensor's tip to dry out.

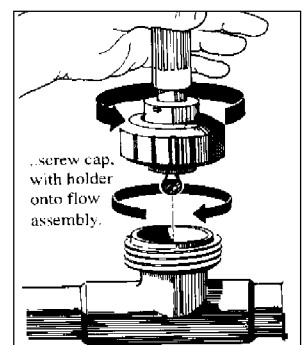

FIGURE 7

ACCESSORIES (not included)

The following accessories are suggested to complete installation.

1. Two manual gate valves, one on each side of the sensor or flow assembly if controller incorporates a flow switch, to isolate the sensor or flow assembly for installation and routine maintenance.
2. One needle valve, for isolating and throttling blowdown assembly if controller incorporates a blowdown valve.
3. Three manual gate valves, for isolating, by-passing and maintenance of water meter, if controller incorporates a water meter (optional).
4. Solenoid valve, if system incorporates blowdown.
5. Two Y-strainers, one before solenoid valve and the other before flow assembly.
6. Chemical metering pumps as required.
7. Contact head water meter, if controller incorporates a pulse timer (optional).
8. External alarm, if controller incorporates alarm relay. (See Figure 1, pg. 5)



!!WARNING!!

Unit must be wired in accordance with all applicable electrical codes.



!!WARNING!!

Line voltage is present on the power supply located behind the Safety/EMI cover behind the front panel. Line voltage is also present on the relay board located in the bottom of enclosure, even when power is off.

POWER MUST BE DISCONNECTED WHILE CONNECTIONS ARE BEING MADE!



!!WARNING!!

When power is supplied to the unit, Line Voltage is present on the relay board located in the bottom of the enclosure, even with the power switch off.

ELECTRICAL WIRING

The controller electronic circuitry is fuse protected (refer to Diagram 10, pg. 38). In addition, each output relay is individually protected by replaceable plug-in 5 amp fuses on the relay board (refer to Diagram 4, 4a, pg. 30, 31). Use of a surge protector is strongly recommended! The device should satisfy the following minimum requirements:

Response Time:	< 1 ns
Energy Dissipation:	400 Joules
EMI/RFI Noise Attenuation:	5-35 dB

The controller should be connected to its own 15 amp power branch (i.e., its own wiring, circuit breaker, etc.) It must be properly grounded.

Prewired units are supplied with 6 foot (1.8 m), 18 AWG (1.2 mm) 3 wire grounded power cords and clearly marked 18 AWG (1.2 mm) 3 wire grounded receptacle cords for all controlled line voltage outputs.

Conduit units are factory predrilled with easily accessible connections for hard wiring. See Diagram 4, 4a, pg. 30, 31, Relay Board, for input and output power connections. **Use only 16 (1.5 mm) or 18 AWG (1.2 mm) wire for conduit power and load connections.**

Use 22 AWG (.76 mm) shielded wire for water meter, remote sensors, etc. Use wire provided with supplied sensors. These signal wires must be run separate from AC power lines.

NOTE: Liquid tight fittings are provided for all signal leads.

When connections are required by the end user, follow the instructions below. All electrical diagrams, circuit boards, etc., are located in Section 6, pages 30-38.

OPEN ENCLOSURE

- Loosen thumb screw on dust cover and lift up.
- Loosen the 2 captive screws from upper control panel, gently swing the panel down on its hinges.

Note: The screws are retained and will not fall out.

FLOW SWITCH OR INTERLOCK

It is recommended that a flow switch or auxiliary dry contact from the control panel be used to make outputs inoperative when cooling tower is shut down. This connection is provided for on all units with or without mounted flow assembly. If a flow switch is not ordered with a unit, this function will be inoperative. To use the interlock feature, connect a flow switch or auxiliary dry contact from another device. See Diagram 4, 4a, pg. 30, 31, Relay Board, for flow switch or interlock connection location (connections are position 11 and position 12 FLOW



NOTE:

For proper rejection of AC line voltage spikes, sensor EMI noise rejection and personal safety, the case ground (SAFETY GROUND) must be properly installed. If there is ANY doubt, consult a qualified electrician.

SWITCH). To activate this function, turn the power switch off. Turn switch S1-“2” on. This switch is located on the mother board (refer to Diagram 7, pg. 34). Wait 15 seconds, and turn power back on.

SENSOR CONNECTIONS

Units supplied with polypropylene flow assemblies come from the factory with all sensors pre-connected. Refer to Diagram 5, 6, pg. 32, 33, Daughter Boards, for location of sensor connections. Use of non-factory provided sensors will void the warranty.

WATER METER (FOR PULSE TIMER)

Electrical wiring is required for water meters. Each individual timer is supplied with its own individual water meter input connection.

The Controller can be configured for up to two water meter inputs that can drive up to two selectable timers. A one water meter system could also drive up to three selectable timers.

For one water meter with two selectable timers, or one water meter with three selectable timers, connect wire jumpers. Refer to Diagram 4, 4a, pg. 30, 31, Relay Board.

ALARM DRY CONTACT

Alarm dry contacts (rated @ 500 mA) are provided when Option K has been ordered for user connection. Refer to Diagram 4, 4a, pg. 30, 31, Relay Board.

RECEPTACLES

The Controller offers a unique prewired package. Each cord is clearly marked and readily accessible for connecting external electrical devices to be controlled. Refer to Section 15, pg. 56, for relay assignment information.



!!WARNING!!

When power is supplied to the unit, line voltage is present on the Relay Board located in the bottom of the enclosure even with the Logic Power switch off.



NOTE:

When Initializing or Re-Initializing your controller, all of the system settings will be overwritten by original factory default settings. The controller must be re-configured to your specifications.

3. START UP INSTRUCTIONS

READ THE FOLLOWING BEFORE PROCEEDING ANY FURTHER!!

INITIALIZATION

Note: If unit has been disconnected from power for a long time period (more than 2 weeks), when powered up the display may indicate charging with a percent value. When adequately charged, the display will AUTO SCROLL to **MAIN MENU**.

Unit requires initialization upon start-up. Before applying power, insure that devices being controlled are not in a position to cause harm or damage if activated upon initial start-up. With the controller now installed in a convenient location, INITIALIZE the Controller. Supply power to the controller and turn the Logic Power switch on. The power LED indicator light will be illuminated. When controller is powered up, the **MAIN MENU-DISPLAY DATA** (shown right) will be displayed.:

1. Press **SCROLL DOWN** until **MAIN MENU-CONFIGURE** is displayed and press **ENTER**.
2. Press **SCROLL DOWN** until **CONFIGURE-FACTORY REINIT** is displayed and press **ENTER**.
3. The Factory Re-Init Warning will be displayed. Continue to scroll down to the end of the warning and then press **ENTER**. Press the **ENTER** key to execute Factory Re-initialization. The unit will revert to **AUTO SCROLL**. Press the **HOME** key repeatedly to return to the **MAIN MENU**. NOTE: You may need to adjust the contrast after completing factory reinit!

Main Menu
Display Data

Main Menu
Configure

Configure
Factory reinit

Warning
Factory reinit

FRONT PANEL

Take a moment to review Figure 8, to become familiar with the controller front panel.

FIGURE 8
Front Panel

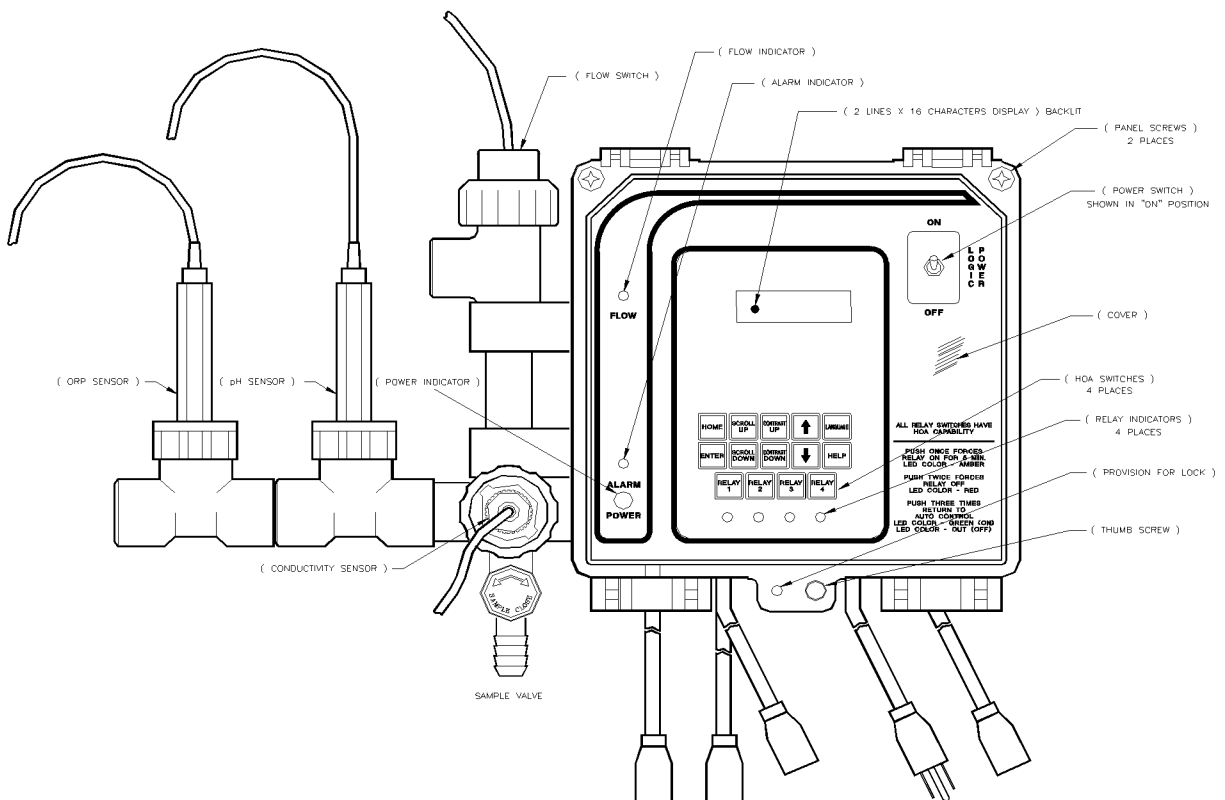



TIP:

For help with menu locations, please refer to the “Menu Map” supplied with your controller.

MENU STRUCTURE

The Controller menu structure as well as the hardware were designed with the user in mind. The laminated “MENU MAP” supplied with your controller reflects your systems menu structure with options.

Display Data This menu displays system parameters only. No settings or adjustments are made through this menu. Present System Conductivity, system pH, and ORP conditions are displayed along with any active alarms.

Calibrate Sensor(s) This menu is for analog input sensor calibration, such as conductivity, make-up conductivity, pH, and ORP. In this menu, the user is prompted to choose either 2 or 3 point calibration. After a choice is made, the user is prompted to enter values of LO, MID (if 3 point is chosen) and HI calibration solution.

Set Points and Alarms In this menu, the user is prompted to enter settings pertaining to alarms and set points that control the system operation.

Inhibitor Feed Set In this menu, the user is prompted to enter settings pertaining to the inhibitor feed mode chosen in the System Configure menu.

Biocide Programs In this menu the user is prompted to enter all settings pertaining to the biocide program timer.

System Configure This is generally the first selection made at start up. In this menu, the user is prompted to configure system functions and options to your specific application. System Configure can include such things as time of day, week, date, security code, track set point or independent set of high/low alarm, display dampener, rising or falling set points, conductivity scale, the selection of the inhibitor feed mode, water meter pulse totalizer, and analog output selection.



NOTE:

After five minutes of no keypad activity, the controller will display date, time, and system conductivity.

KEY PAD OPERATION

The Key Pad is easy to use and will guide you through all the sub menus and functions of the controller.

Feel free to try out these keys as you read about them. You will not hurt the controller and the values will need to be reprogrammed later anyway.

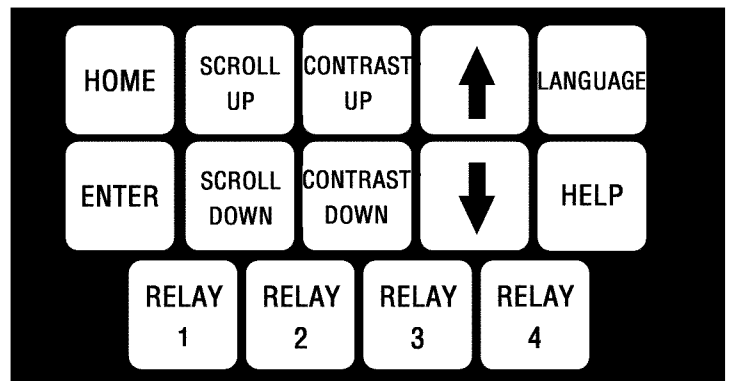

Home Press this key to return to previously displayed menu.

Scroll Up/Scroll Down Some menus contain more than one page. Press either scroll key to reveal other items on menu displayed. If no other choices are present, nothing will happen when pressing Scroll Keys. The Menu Map supplied with your controller will show you which menus need to be scrolled to show additional choices.

Contrast Up/Contrast Down Press these keys to control contrast of viewing screen.

Arrows The Arrow Keys are used to change the numerical values associated with the various settings you will be entering. Use “down” arrow to select lower numbers and the “up” arrow to select higher numbers.

Enter This key has two functions:

FIRST, within the sub menu, pressing the Enter Key will activate the selection.

SECOND, after selecting the value needed with the Arrow Keys, press the Enter Key to “lock-in” the value. The next value to be set (if one exists) in that particular sub-menu will be displayed.



TIP:

When using the Arrow Keys, press once to change numbers by one unit. Hold down either Arrow Key to change numbers more rapidly.

Language This key is used for alternative foreign languages for our international customers. Spanish is installed as standard feature on these controllers.

Help When pressed, this key will display simple instructions for the operation of the Enter, Home, Arrows, and Scroll keys.

Relays (1-4) These Hand/Off/Auto (HOA) keys allow immediate control of pumps, solenoid valves, etc. affected by the controller without scrolling through the menus. Press a Relay Key once to force relay on for 5 minutes (an amber light will appear below that key). Press the Relay Key again to force the relay off (a red light will appear below that key, relay will be forced off until key is pressed again). Press the Relay Key a third time to return the relay to auto control (green light will indicate that relay is on, no light indicates that relay is not activated).



!!WARNING!!

NEVER leave a screen with choices still “flashing”! Controller accuracy may be affected, and/or controller may not operate properly. If you forget, simply return to that menu and complete your programming.

SAMPLE PROGRAMMING

The following is a detailed example of how to program your controller. Once you have mastered this exercise, you will be ready to set up the controller to your specifications.

IMPORTANT! Please note that in all programming instructions, *keypad instructions* are presented as all capitals—“ENTER,” items as they *appear in the display* are presented as all capitals and bold face—“**DISPLAY DATA.**”

For this exercise, you will set “**DAY, WEEK, DATE, and TIME.**”



1. If not already displayed, press HOME until **MAIN MENU DISPLAY DATA** is displayed.



2. Press SCROLL DOWN repeatedly until **MAIN MENU CONFIGURE** is displayed.

Press ENTER.



3. **CONFIGURE DATE/DAY/TIME** will be displayed.

Press ENTER.

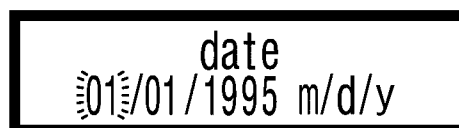

4. The **DATE** menu will be displayed with “month” flashing. Use the ARROW keys to select the current month.

Press ENTER.

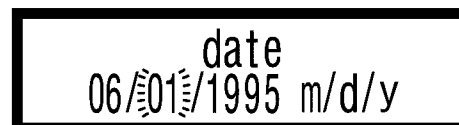

5. “Day” will begin flashing. Use the ARROW keys to select the current date.

Press ENTER.

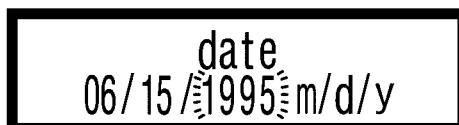

6. “Year” will begin flashing. Use the ARROW keys to select the current year.

Press ENTER to complete



TIP:

Be sure to press keys firmly until you feel or hear a faint click, then pause before you try again. There is a very slight delay for the controller to react to your command. This is normal.



TIP:

If at any time, while programming your controller, you get lost or confused, press the HOME key repeatedly until you get back to the Main Menu and start again.

(Continued)

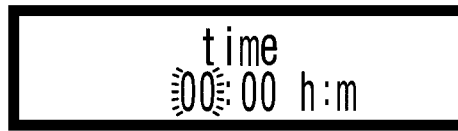

DATE programming.

7. Press **SCROLL DOWN**. The **TIME** menu will display with “hours” flashing. Use the **ARROW** keys to select current hour (24 hour clock).

Press **ENTER**.

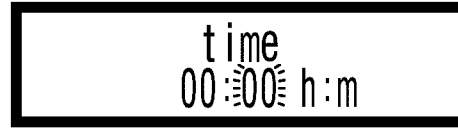

8. “Minutes” will begin flashing. Use the **ARROW** keys to select current minutes.

Press **ENTER**.

If Biocide Option E, F, or G is present on your controller, you will also configure “Week/Day”. If not, configuring “Date/Day/Time” would be complete at step 8 above.



9. Press **SCROLL DOWN**. The **WEEK/DAY** menu will display with “1st wk” flashing. Use the **ARROW** keys to select either 1st, 2nd, 3rd, or 4th wk.

Press **ENTER**.



10. “Day” will begin flashing. Use the **ARROW** keys to select the day of the week you prefer.

Press **ENTER**. Nothing should be flashing and that completes the Date, Day, and Time programming.

Congratulations, you’ve done it! All menu programming functions operate in this manner. Feel free to repeat this exercise as often as you like until you are comfortable with the programming procedure.

Now, press the **HOME** key repeatedly to return to **MAIN MENU, DISPLAY DATA**.



!!!WARNING!!!

When power is supplied to the unit, line voltage is present on the Relay Board located in the bottom of the enclosure even with the Logic Power switch off.



NOTE:

When Initializing or Re-Initializing your controller, all of the system settings will be overwritten by original factory default settings. The controller must be re-configured to your specifications.



TIP:

After pressing ENTER at the end of a setting procedure, if the next item to be set within a submenu does not display, press the HOME key to return to the submenu title then press SCROLL UP or SCROLL DOWN until you see the item to be set next.

4. CONTROLLER SET UP

GENERAL INFORMATION

Before applying power, insure that devices being controlled are not in a position to cause harm or damage if activated upon initial start-up. With the controller now installed in a convenient location, INITIALIZE Controller (see initialization procedure, pg. 9). Supply power to the controller and turn power switch on. The power LED indicator light will be illuminated. When controller is powered up, it will show **MAIN MENU-DISPLAY DATA** in the display.

If display contrast requires adjustment, use the CONTRAST UP or CONTRAST DOWN keys on the control panel key pad to adjust screen for best viewing.

The default values for all Control features have been factory set, but you will want to fine tune the controller to meet your specific application.

SYSTEM CONFIGURE

To configure the controller, press HOME until **MAIN MENU DISPLAY DATA** appears in the display. SCROLL DOWN until **MAIN MENU-CONFIGURE** is displayed, then proceed with the following.

A) Set DATE/DAY/TIME:

1. Please refer to Sample Programming (pg. 11).
2. When completed, press HOME once to return to **MAIN-MENU CONFIGURE**.

B) Set SECURITY Access Code:

The Controller can be configured to have a Security Access Code. One must know this code to access the System Configure menu. **Note: System Configure Security provides security for the System Configure Menu, only.**

1. Press SCROLL DOWN to display **CONFIGURE-SECURITY** and press ENTER. **SECURITY CODE-DISABLED** will appear.

To set a security code, press the UP ARROW key to program the desired code and press ENTER. Once a security code has been entered, the operator must know the code to access **MAIN MENU-CONFIGURE**.

2. To disable the code after it has been entered, you must first know the code. Enter the security code with the ARROW keys then, press SCROLL DOWN to display **CONFIGURE-SECURITY** and press ENTER.
3. Press and hold DOWN ARROW key until display shows **DISABLED** and press ENTER.
5. Press HOME once to return to **CONFIGURE-SECURITY** menu.

C) Set HI/LO ALARM:

You have the choice to select “Track Set Point” or “Independent Set Point.” Selecting “Track Set Point” will cause the Hi and Low alarms to “Track” the setpoint by a given offset. In this case you specify only an offset. The Hi alarm point is calculated by adding the offset to the setpoint. The Low alarm point is calculated by subtracting it. Selecting “Independent Set Point” allows you to set the Hi and Low alarm values independently.

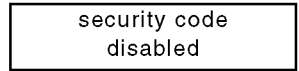
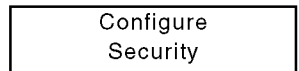
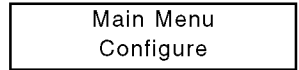
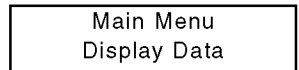
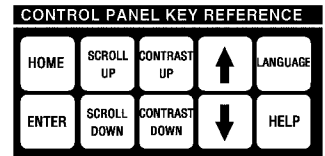
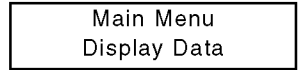



TIP:

After pressing ENTER at the end of a setting procedure, if the next item to be set within a submenu does not display, press the HOME key to return to the submenu title then press SCROLL UP or SCROLL DOWN until you see the item to be set next.

1. SCROLL DOWN to **CONFIGURE-HI/LO ALARM**. Press ENTER and use the ARROW keys to choose the alarm configuration: **TRACK SET PT** or **INDEPENDENT SET** of high and low alarms. Press ENTER when your choice is displayed. An asterik (*) will appear next to your selection. Press HOME to return to **CONFIGURE-HI/LO ALARM**.

Configure
Hi/Lo Alarm

hi/lo alarm
*track set point

hi/lo alarm
*independent set point

D) Set DISPLAY DAMPENER:

This setting determines the number of samples that are averaged together and the number of seconds before a new reading is displayed. This reduces the typical fluctuation of digital displays.

1. SCROLL DOWN to **CONFIGURE-DISPLAY DAMPENER**. Press ENTER, **DISPLAY DAMPENER-EVERY 1 SEC(S)** will display. Set sensitivity or display dampening with the ARROW keys, 1 being the most sensitive and 20 being the least. Press ENTER. Press HOME to return to **CONFIGURE-DISPLAY DAMPENER**.

Configure
Display Dampener

display dampener
every 1 sec(s)

Note: Does not affect control.

E) Set CONTROL SET POINT:

This setting gives you the option to configure either a rising or falling set point for Conductivity, pH, and ORP (if equipped) values. A rising set point means that relays are activated above the set point, falling set point means that relays are activated below the set point. Depending on which model of the controller you have, your choice of control set point will be available for System Conductivity, System pH, and/or System ORP. All configure in the same manner as described below.

1. SCROLL DOWN to **CONFIGURE-CONTROL SET PT**. Press ENTER.
2. **SYS COND SET PT-RISING* FALLING** will display with the asterik (*) next to **RISING** or **FALLING**. Choose **RISING** or **FALLING** set point by placing asterik (*) next to your selection with the ARROW keys. Press ENTER.
3. Press SCROLL DOWN to select control set point for pH and/or ORP and program as described in step 2 (if available on your controller).
4. When completed, press HOME to return to **CONFIGURE-CONTROL SET PT**.

Configure
Control Set Pt

sys cond set pt
rising* falling

F) Set INPUT SCALE/RANGE:

This selection lets you choose the conductivity range you wish your controller to monitor.

1. SCROLL DOWN to **CONFIGURE-INPUT SCALES**. Press ENTER. The display will show current scale selected with asterik (*) next to it. Important: If the scale is changed, the keypad becomes inoperative for 15 seconds and **PLEASE CHANGE SWITCH ON CARD** will be displayed. This is a reminder that a switch on the daughter board must also be changed. Refer to the following Table. After 15 seconds, press HOME to return to: **CONFIGURE-INPUT SCALES**.

Configure
Input Scales

sys cond us / cm
*5000 switch 3

Please change
switch on card



!!WARNING!!

If the Scale-Range is changed (present scale will display in the “Main Menu, Display Data” menu when you press the Home key), the keypad becomes inoperative for 15 seconds. A reminder will appear that a switch on the daughter board must be changed also! See table at right for proper switch configuration.

Scale/Range Table (refer to Diagram 5, Conductivity Daughter Board, pg. 32)

	S2-"5"	S2-"4"	S2-"3"	S2-"2"	S2-"1"
0-500					•
0-2,000				•	
0-5,000			•		
0-10,000		•			
0-20,000	•				

• = Closed (or On)

Your Controller comes from the factory pre-configured to monitor conductivity in the range of 0-5,000 $\mu\text{S}/\text{cm}$. The ranges listed in the Scale/Range Table can be selected by the setting of the five dip switches located just left of the sensor input on the conductivity daughter board. Refer to Diagram 5, pg. 32.

Note: Assure that only one scale switch is in the closed position. The corresponding range must also be selected from the keypad under **MAIN MENU-CONFIGURE**.

If your controller is equipped with the make-up conductivity option, a “mu cond” item will also appear under the “input scale” menu.



NOTE:

Recalibrate conductivity sensor after changing scale.

G) Set SELECTABLE INHIBITOR TIMER

This selection lets you choose the method desired to control the operating duration of the inhibitor feed pump when activated.

1. **SCROLL DOWN** to **CONFIGURE-INH TIMER SELECT**. Press **ENTER**.
2. **INH SELECT - LIMIT TIMER, PERCENT TIMER, PULSE TIMER OR % POST BLEED** will display. An asterisk (*) will be next to the presently selected mode.
3. Press either **ARROW** key to display your choice.
4. Press **ENTER**, an asterisk (*), indicating present feed mode, will appear next to your selection.
5. Press **HOME** to return to **CONFIGURE-INH TIMER SELECT**.

Configure
Inh Timer Select

inh select
limit timer

inh select
percent timer

inh select
pulse timer

inh select
*% post bleed

H) Set TOTALIZER

The Totalizer displays the accumulated number of pulses received from a contact head equipped water meter. This selection lets you reset or enter a count value.

1. **SCROLL DOWN** to **CONFIGURE-RESET TOTALIZER**.
2. Press the **ENTER** key to display **COUNT TOTAL**. To **RESET TOTALIZER**, use the **ARROW** keys to set the reset to zero or the desired count and press **ENTER**.
3. Press **HOME** to return to **RESET TOTALIZER** menu.

Configure
Reset Totalizer

count total
0



NOTE:

TOTALIZER keeps track of water meter pulses. Totalizer will count even if the system is not in pulse timer feed mode and a water meter with a contact head is connected. See configure menu.

I) Set ANALOG OUTPUT

Analog outputs are designed for interfacing with recorders, pumps and computers.

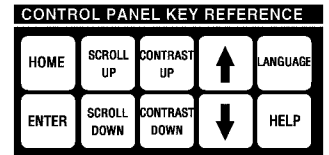



!!WARNING!!
 controller could be
 damaged and void
 warranty!

Analog outputs are
 self powered. Do not
 try to externally loop
 power.
 Externally powered
 outputs will damage
 your controller!



TIP:

For help with menu
 locations, please refer
 to the “Menu Map”
 supplied with your
 controller.

The programmable option is an Isolated Proportional 4-20 mA output, designed to interface with an analog recorder, metering pump or computer. The output is 4-20 mA over a programmable range. For example, if the analog input was pH, the output could be programmed to be 4 mA at 6.7 pH, the “LO RANGE” set point, and 20 mA at 8.2 pH, the “HI RANGE” set point”.

Analog outputs require calibration upon initial start up. Calibration is recommended after changing scales or after factory reinitialization. For accurate calibration of the analog output, a milliamp meter is required.

Calibration

Note: LO = 4 mA
 HI = 20 mA

1. Remove signal wires if installed and connect a milliamp meter to output connections on daughter board. Observe proper polarity (+/-). Refer to Diagram 8, pg. 35, for connections. **Note:** The Diagram reflects a dual or 2 channel board. Depending on your controller model, there may be connections for only one output.
2. SCROLL to **CONFIGURE-D/A OUT SELECT** under the **MAIN MENU-CONFIGURE** menu. Press ENTER.
3. **D/A OUT #1 PARAM** will be displayed on the first line. The second line will display system conductivity, pH, or ORP (depending on model of your controller) to be monitored or controlled. If more than one analog output is present, use the ARROW keys to display the analog input to be tagged to analog output. Present analog input is designated by an asterisk (*). Press ENTER.
4. Press ENTER and SCROLL DOWN to **LO ADJUST**. As indicated on the display, use the ARROW keys to calibrate the “lo” mA reading (4 mA) on the external milliamp meter. Press ENTER to enter the adjustment.
5. SCROLL DOWN to **HI ADJUST**. As indicated on the display, use the ARROW keys to calibrate the “hi” mA reading (20 mA) on the external milliamp meter. Press ENTER to enter the adjustment.
6. If controller is equipped with the programmable option, SCROLL DOWN to **LO RANGE**. As indicated on the display, use the ARROW keys to set the “lo range” set point. Press ENTER to enter the adjustment. SCROLL DOWN to **HI RANGE**. As indicated on the display, use the ARROW keys to set the “hi range” set point. Press ENTER to enter the adjustment.
7. Press SCROLL DOWN for additional analog outputs to be set, or press HOME repeatedly to return to **MAIN MENU-CONFIGURE**.
8. Remove milliamp meter and connect analog recorder, metering pump or computer. Be sure to maintain proper polarity when connecting external devices!

Configure
 D / A Out Select

D / A out #1 param
 * sys cond

D / A #1 lo adjust
 ARROWS to change

D / A #1 hi adjust
 ARROWS to change

D / A #1 lo range
 0 us/cm

D / A #1 hi range
 5000 us/cm



TIP:

For help with menu locations, please refer to the “Menu Map” supplied with your controller.



NOTE:

If duplicate functions are present, a number designation will be displayed with the alarm conditions.

For example: “high alarm 1” and “high alarm 2”.



NOTE:

On models with more than one input, a number designation will be displayed with “set point”. Also models equipped with pH and ORP controls, will also have a display to set desired “limit timer”.

J) Set ALARM OUTPUT RELAY, ALARM DRY CONTACT

The alarm output relay provides an alarm relay output of line voltage which can activate an alarm or other device.

The alarm dry contact provides provides an alarm dry contact which can be interfaced with a computer or energy management system. Make electrical connections for the alarm dry contact on terminal strip as follows (refer to Diagram 4, 4a, Relay Board, pg. 30, 31, for connections) :

- Connection 1 Relay Common A1
- Connection 2 N.O. A2
- Connection 3 Relay Common B1
- Connection 4 N.O. B2

These controllers allow the user to program which alarms will activate the alarm output. This can be accomplished in the SYSTEM CONFIGURE menu under **CONFIGURE-ALARM RELAY SEL.**

Continue by configuring the controller alarm relay output functions. **SCROLL UP** or **SCROLL DOWN** to **MAIN MENU CONFIGURE**

1. **SCROLL DOWN** to **CONFIGURE-ALARM RELAY SEL** under the **MAIN MENU-CONFIGURE** menu. Press **ENTER**.
2. **ALARM RELAY SEL-HIGH ALARM** will display. Press **ENTER** and an asterisk (*) will appear or disappear. The asterisk (*) indicates that the alarm condition will activate output.
3. Use the **ARROW** keys to display other alarm conditions to be activated or deactivated. Press **HOME** to return to **CONFIGURE-ALARM RELAY SEL.**

K) View VERSION NUMBER

This selection allows the user to determine the version of software installed in your controller.

1. **SCROLL DOWN** to **CONFIGURE-VERSION NUMBER** under the **MAIN MENU-CONFIGURE** menu. Press **ENTER**.
2. Present version number will display on your screen. Press **HOME** repeatedly to return to **MAIN MENU-DISPLAY DATA.**

SET POINTS AND ALARMS

Rising or Falling Set Point

The setting at which the controller activates an output, such as a solenoid valve when the conductivity set point is exceeded or an acid pump when pH exceeds the desired limit, or a chemical pump if the ORP set point is exceeded (depending on the model number of your controller).

1. Press **SCROLL UP** or **SCROLL DOWN** until **MAIN MENU-SET PTS & ALARMS** is displayed. Press **ENTER**.
2. **SET POINT 1** and the factory setting or the last set point entered will be displayed flashing on the second line. Use the **ARROW** keys to set the desired set point, press **ENTER**.

High or Low Alarm Settings

Every analog input has a high/low alarm indicator. The alarms can be configured one of two ways. The controller is factory configured to track the set point. An alarm offset is entered which sets the alarm point above and below the set point of the controller. Example: With an “ALARM OFFSET” of 200, if the set point is 1200, the high alarm would be at 1400 and the low

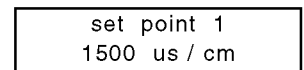
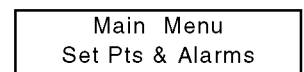
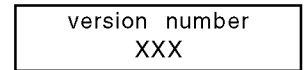
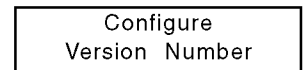
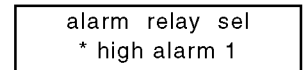
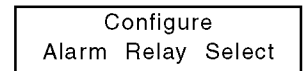
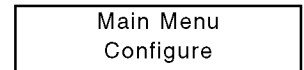
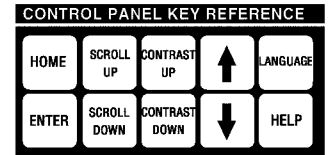



TIP:

For help with menu locations, please refer to the “Menu Map” supplied with your controller.



NOTE:

Set “Track” or “Independent” Set point in the MAIN MENU-Configure menu. See C), pg. 13.



TIP:

To reset timer:

- 1) Interrupt flow through flow assembly, if installed.
- 2) Satisfy the condition by manually feeding, etc.



NOTE:

When configuring Inhibitor Feed Timer in System Configure menu, you may select only one of four (4) possible feed modes.

alarm at 1000. The high/low alarms can also be configured with independent set points for the “High Alarm” and the “Low Alarm”. This is accomplished through CONFIGURE-HI/LO ALARM under the MAIN MENU-CONFIGURE menu.

3. If “track set point” was selected during the system configure procedure, skip steps 5 and 6. SCROLL DOWN to **ALARM OFFSET 1**. The factory setting or the last alarm offset entered will be displayed flashing. Use the ARROW keys to set the desired alarm offset, press ENTER.

alarm offset
200 us / cm

4. Press SCROLL DOWN to display **HIGH ALARM 1** value and press SCROLL DOWN again to view **LO ALARM 1** value. No settings can be made if “track set point” was selected.

set point 1
1500 us / cm

5. (If “independent set point” was selected during the system configure procedure) SCROLL DOWN to **HIGH ALARM 1**. The factory setting or the last high alarm entered will be displayed flashing. Use the ARROW keys to set the desired high alarm setting, press ENTER.

high alarm 1
1700 us / cm

lo alarm 1
1300 us / cm

6. SCROLL DOWN to **LO ALARM 1**. The factory setting or the last low alarm entered will be displayed flashing. Use the ARROW keys to set the desired low alarm setting, press ENTER.

high alarm 1
1600 us / cm

lo alarm 1
1000 us / cm

Set Point Differential

Also referred to as dead band or hysteresis. This is the offset applied to a set point to prevent chattering of an output relay around a set point.

7. SCROLL DOWN to **SET POINT DIFF 1**. The factory setting or the last set point differential entered will be displayed flashing. Use the ARROW keys to set the desired differential, press ENTER.

set point diff
100 us / cm

8. SCROLL DOWN to **SET POINT 2** (if available on your controller). The factory setting or the last set point entered will be displayed flashing. Use the ARROW keys to set the desired set point, press ENTER.

set point 2
7.40 ph

9. Repeat steps 3 through 7 and proceed with steps 10 and 11.

Limit Timer (pH and Conductivity/pH Controller)

Also referred to as lockout timer or feed limit timer. Displayed only if the analog input, pH or ORP is available on your controller. This limits the amount of time output is activated. The timer is adjustable in one minute increments up to 24 hours; factory set for 1 hour, 30 minutes.

10. SCROLL DOWN to **LIMIT TIMER 1 (or 2)**. The factory setting or the last time entered will be displayed flashing. Use the ARROW keys to set the desired limit time, press ENTER.

limit timer
00:00 h:m 01:30

11. Press HOME repeatedly to return to **MAIN MENU-DISPLAY DATA**.

SELECTABLE INHIBITOR FEED TIMER

The inhibitor feed timer is selectable. The user can choose one of four timer modes to base the addition of inhibitor. The selection of timer modes is made in MAIN MENU-CONFIGURE. Only the “Inhibitor Feed Mode” selected will be displayed in MAIN MENU-INH FEED SET menu.

Note: Refer to the following timer mode instructions for the mode you have selected.



!!WARNING!!

If "acc set" is entered as zero (0), the pulse timer will run continuously.



NOTE:

Pulse count may also be read in the INHIBITOR FEED SET main menu if system is configured for pulse timer.



NOTE:

If multiple timers have been installed on your controller, SCROLL DOWN would allow you to move from Timer 1 to Timer 2. Press the ENTER key to select the timer you are prompted to set.

Pulse Timer/Accumulator

Also referred to as water meter timer or reset timer. The timer accepts pulses from a water meter to actuate a chemical feed pump. The timer has an adjustable feed time "RUN TIME" in 1 second increments up to 59 minutes and 59 seconds with an elapsed time display. The timer has a built in accumulator "ACC CT/ACC SET" that can count pulses up to 255 before activating output with an elapsed pulse counter. Also incorporated into the timer is a pulse totalizer "COUNT TOTALIZER" that keeps an ongoing count of the number of pulses received by the timer. This pulse totalizer can be reset to 0 or any other number. This is accomplished in the Configure menu.

Note: The accumulator count (ACC CT) will store pulses up to the accumulator set (ACC SET) value if received while pumping. Additional pulses will not be accumulated until the run time is satisfied. However, the count totalizer will continue to totalize.

1. SCROLL UP or SCROLL DOWN through the displayed main menus to **MAIN MENU-INH FEED SET**. Press ENTER.
2. **INH FEED MODE-PULSE TIMER** will be displayed.
3. SCROLL DOWN to **RUN TIME**. The display will prompt you to enter the minutes and seconds with the ARROW keys. Press ENTER after each selection.
4. SCROLL DOWN to **ACC CT/ACC SET**. The number of pulses desired will be displayed flashing. Enter the number of pulses desired to activate timer with the ARROW keys, press ENTER. The present number of pulses, **ACC CT** (accumulation count), received is displayed to the left of the **ACC SET** entry.
5. SCROLL DOWN to **COUNT TOTALIZER** to read total pulses received from water meter. This number multiplied by gallons per contact of the water meter equals the total gallons used. This can be reset from **MAIN MENU CONFIGURE**.
6. Press HOME key repeatedly to return to **MAIN MENU-DISPLAY DATA**.

Feed Limit Timer

Also referred to as lock-out timer. The chemical feed pump is actuated based on conductivity, simultaneously with blowdown. The timer limits the length of time the pump can be activated during any single bleed cycle, preventing overfeeding that could occur if the blowdown line were clogged. The timer is adjustable in 1 minute increments up to 23 hours and 59 minutes with an elapsed time display.

1. SCROLL UP or SCROLL DOWN through the displayed main menus to **MAIN MENU-INH FEED SET**. Press ENTER.
2. **INH FEED MODE-LIMIT TIMER** will be displayed.
3. SCROLL DOWN to **FEED LIMIT TIME**. The display will prompt you to enter the hours and minutes with the ARROW keys, press ENTER after each selection.
4. Press HOME key repeatedly to return to **MAIN MENU-DISPLAY DATA**.

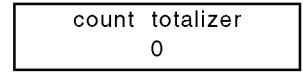
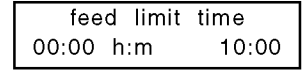
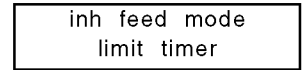
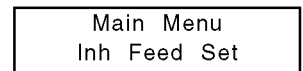
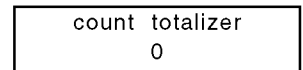
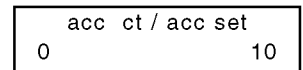
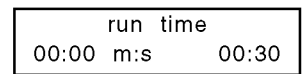
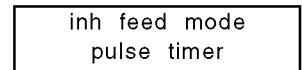
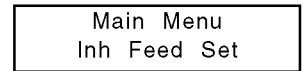
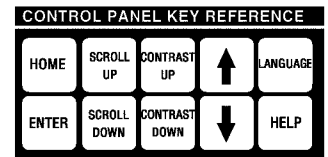



TIP:

For help with menu locations, please refer to the “Menu Map” supplied with your controller.

Percent Timer

Also referred to as cycle timer. The timer runs continuously on an adjustable time (1 to 120 minutes) cycle, with the outputs being activated for an adjustable percentage of the time cycle. The timer is adjustable in 1 percent increments up to 100 percent of the cycle time.

1. SCROLL UP or SCROLL DOWN through the displayed main menus to **MAIN MENU-INH FEED SET**. Press ENTER.
2. **INH FEED MODE-PERCENT TIMER** will be displayed.
3. SCROLL DOWN to **PERCENT ON**. The display will prompt you to enter the desired percentage with the ARROW keys, press ENTER.
4. SCROLL DOWN to **% OF MINUTES**. Use the ARROW keys to enter the amount of time the timer will cycle, press ENTER.
(Example: 10 minute percent timer set at 50% will be on for five minutes, off for five minutes.)
5. Press HOME key repeatedly to return to **MAIN MENU-DISPLAY DATA**.

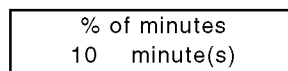
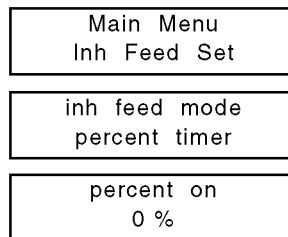

Post Blowdown Percent Timer “% post blowdown”.

This timer is adjustable in 1 percent increments up to 100 percent of the blowdown time. The timer keeps track of the total blowdown time and activates the chemical feed for the percent of total blowdown time set. The chemical feed occurs after blowdown is complete.

1. SCROLL UP or SCROLL DOWN through the displayed main menus to **MAIN MENU-INH FEED SET**. Press ENTER.
2. **% POST BLOWDOWN** will be displayed.
3. SCROLL DOWN to **% BLOWDOWN FEED**. The display will prompt you to enter the desired percentage with the ARROW keys, press ENTER.
4. Press HOME key repeatedly to return to **MAIN MENU-DISPLAY DATA**.

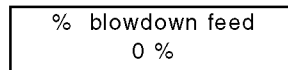
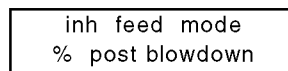
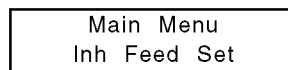

NOTE:

If programs are not set or if set to ‘no wk’ after being programmed, they will not activate.

BIOCIDE PROGRAMMING

Controller biocide programs are on a 28 day cycle. Each biocide has four individual programs with a wide range of day and week setting combinations. The biocide program timers incorporate blowdown lock-out with pre-blowdown on those controllers incorporating conductivity control.

1. SCROLL UP or SCROLL DOWN through the displayed main menus to **MAIN MENU-BIOCIDE PROGRAM**. Press ENTER.
2. **BIOCIDE A** will be displayed. SCROLL DOWN again for **BIOCIDE B** or once again for **BIOCIDE C** (if available).
3. Press ENTER and **BIO A WK/DY #1** will be displayed. The second line displays, NO WK and FRI or the last settings entered.
4. Use the ARROW keys to set the desired week, press ENTER. **FRI** (or last day programmed) will flash. Use the ARROW keys to set desired day and press ENTER.

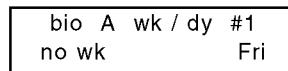
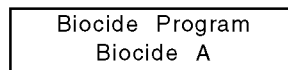
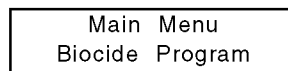

BIOCIDE “WEEK” SETTINGS

NO WEEK	4TH WEEK
1ST WEEK	EVEN WEEK
2ND WEEK	ODD WEEK
3RD WEEK	EVERY WEEK

BIOCIDE “DAY” SETTINGS

SUN	THU
MON	FRI
TUE	SAT
WED	EVERY

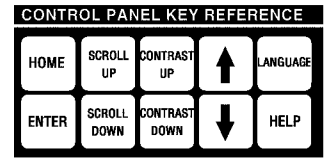

NOTE:

Time settings are based on a 24 hour clock. For example, 1:00 P.M. would be programmed as 13:00.

Program Start Time (BIO A START TIME)

The four programs have individual program start times. If your system incorporates conductivity control, pre-blowdown would activate the biocide program at this time. If not, biocide feed would activate at this time.

5. **SCROLL DOWN** to **BIO A START TIME**. Use the **ARROW** keys to set the desired start time hours, press **ENTER**. **Note: Time settings are based on a 24 hour clock. For example, 1:00 pm would be programmed as 13:00.** Use the **ARROW** keys to set desired start time minutes, press **ENTER**. This is the time program #1 is to activate.

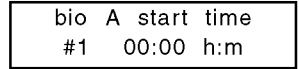

6. **SCROLL DOWN** to **BIO A WK/DY #2**. Repeat steps 3 through 5 for biocide A program #2.

7. **SCROLL DOWN** to **BIO A WK/DY #3**. Repeat steps 3 through 5 for biocide A program #3.

8. **SCROLL DOWN** to **BIO A WK/DY #4**. Repeat steps 3 through 5 for biocide A program #4.

Length Of Feed Time (BIO A RUN TIME)

The length of time biocide A feed pump is to operate. Adjustable in one minute increments up to 23 hours 59 minutes. Default 01:30.

9. **SCROLL DOWN** to **BIO A RUN TIME**. Use the **ARROW** keys to set the hours of desired feed time, press **ENTER**. Use the **ARROW** keys to set the minutes of desired feed time, press **ENTER**. This is the run time that the biocide A pump is to feed.

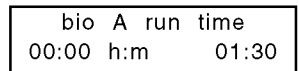

Note: If conductivity is present on your model, continue with step 10. For pH controller with biocide options continue with step 13. These functions are only present if conductivity control is incorporated.

Pre-Blowdown (Bleed) (BIO A PREBLD TIM)

The pre-blowdown function of this controller allows the user to pre-blowdown in advance of blowdown (bleed) lock-out, to reduce the possibility of scaling due to increased TDS levels. Pre-blowdown is programmed for a length of time that begins at the biocide program start time (“BIO A START TIME”) and continues for the length of time programmed or until the preset conductivity low limit, “PRE-BLD COND MIN” has been reached.

Adjustable in one minute increments up to 23 hours 59 minutes (default 00:00). Minimum conductivity default at 0µS/cm.

10. **SCROLL DOWN** to **BIO A PREBLD TIM**. Use the **ARROW** keys to set the hours of desired pre-bleed time, press **ENTER**. Use the **ARROW** keys to set the minutes of desired pre-blowdown time, press **ENTER**. This is the amount of time that the controller will pre-bleed.

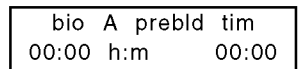

11. **SCROLL DOWN** to **PRE-BLD COND MIN**. Use the **ARROW** keys to enter the minimum conductivity, press **ENTER**. This is the minimum conductivity that the controller will pre-blowdown.

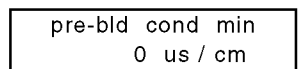

Blowdown Lock-Out (BIO A BLD LKOUT)

The length of time blowdown (bleed) is to be locked is out during and after biocide feed. The lock-out time starts when **BIO A START TIME** is activated. Adjustable in one minute increments up to 23 hours 59 minutes (default 00:00).



TIP:

See the Biocide Programming Work Sheet in Section 13, page 54 of this manual.

12. **SCROLL DOWN** to **BIO A BLD LKOUT** . Use the **ARROW** keys to set the hours of desired blowdown lock-out time, press **ENTER**. Use the **ARROW** keys to set the minutes of desired blowdown lock-out time, press **ENTER**. This is the amount of time that the controller will lock out the blowdown (bleed). The default value 00:00 disables the bleed lockout.

bio A bld lkout		
00:00	h:m	00:00

13. Press **HOME** to return to **BIOCIDE A**. If multiple biocides are present, continue with step 14. If not, continue with step 16.

14. **SCROLL DOWN** to **BIOCIDE B**. Press **ENTER** and program in the same manner as **BIOCIDE A**, beginning with step 5. Press **HOME** to return to **BIOCIDE B**. If multiple biocides are present continue with step 15. If not, continue with step 16.

15. **SCROLL DOWN** to **BIOCIDE C**. Press **ENTER** and program in the same manner as **BIOCIDE A**, beginning with step 5.

16. Press **HOME** key repeatedly to return to **MAIN MENU-SYSTEM DATA**.



!!WARNING!!

Two of the determining factors for the sensor cell constant are the volume of the solution and area of the sampling chamber. If any other container, such as a plastic cup, is used in place of a calibration kit (CALKIT) or on-line sample tee, the calibration will be inaccurate.

5. SENSOR CALIBRATION/INFORMATION

Important: Verify calibration before proceeding with final system start-up. Make sure sensors are clean (refer to Section 10, Maintenance, pg. 48) before proceeding with system calibration.

See Section 13. Additional Calibration Techniques

CONDUCTIVITY CALIBRATION

Conductivity Function Calibration Notes

A Controller Calibration Kit, fig. 9 (CAL KIT, not included) is available to assist in proper calibration of conductivity sensors. The CAL KIT provides the same physical area for a sample chamber as your on-line sample stream assembly and three standard calibration solutions.

Conductivity Calibration, 2 point method Sensors: Carbon-Graphite, Platinum Black

1. Condition the new Carbon-Graphite Sensor by soaking it in water for 5 minutes before proceeding with calibration. This step is required for new sensors or sensors that are not in service at the time of calibration. Clean sensor before calibration by first flushing with fresh water. Inspect to assure sensor is free of deposits.
2. Set **DISPLAY DAMPEN** to 1 sec. (Refer to System Configure Menu, pg. 14, paragraph **D**).
3. Obtain a sample of system water and test the sample with a reliable, calibrated tester (see figs. 10 and 11.) Make note of reading.
4. Close isolation valves and relieve pressure on the system by opening the sample valve. Remove and place sensor into the sample container with distilled or deionized water for a value of zero (0) to enter as the "LOW" calibration point in the following procedure (see fig. 12). If deposits or fouling is present, clean sensor per instructions in Section 10, Maintenance, pg. 48.

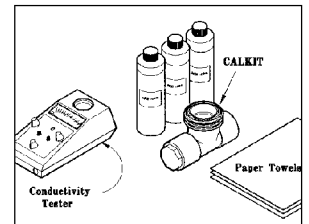

FIGURE 9
CALKIT shown with tester and paper towels.

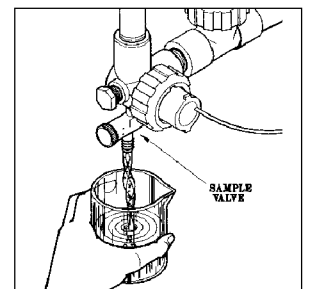

FIGURE 10
Securing a sample of cooling tower water.

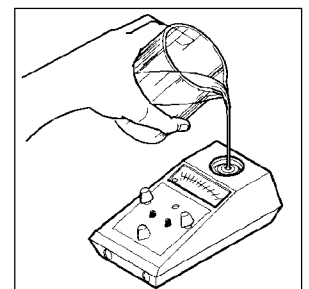

FIGURE 11
Pouring cooling tower sample water into tester.



NOTE:

Be sure to allow sensor to stabilize for at least 2 minutes each time its environment is changed before evaluating readings.



Tip:

For best results, calibrate one point as close to the control set point as possible.

5. Press HOME key until **MAIN MENU-DISPLAY DATA** is displayed. SCROLL DOWN to **MAIN MENU-CALIBRATE SENSOR**. Press ENTER.

6. **CALIBRATE SENSOR** will be displayed on the first line with the sensor to be calibrated on second line. SCROLL DOWN, if necessary, to display **CALIBRATE SENSOR-SYS COND**. Press ENTER.

7. **SYS COND CALIBRA** will be displayed on the first line with **2 POINT** and **3 POINT** on second line. Use ARROW keys to position asterisk (*) next to **2 POINT***. Press ENTER.

8. SCROLL DOWN to display **SYS COND LOW CAL**. Use ARROW keys to input **0 US/CM** and wait two minutes with unit flashing “0.” Press ENTER.

9. Reinstall conductivity sensor into flow assembly (see fig. 13), close sample valve, and open isolation valves.

10. SCROLL DOWN to display **SYS COND HI CAL.** Use ARROW keys to enter the reading obtained by the Conductivity Tester in step 1 and wait two minutes with the entered reading (xxx) flashing. Press ENTER.

11. Press HOME repeatedly to return to **MAIN MENU-DISPLAY DATA**. Press ENTER to display data to verify calibration.

Conductivity Calibration, 2 point method

Sensors: Stainless Steel

1. Set **DISPLAY DAMPENER** to 1 sec. (Refer to System Configure Menu, pg. 14, paragraph D).

2. Obtain a sample of system water and test the sample with a reliable, calibrated tester (see figs. 10 and 11, pg. 22). Make a note of the reading.

3. Close isolation valves and relieve pressure on the system by opening the sample valve.

4. Remove sensor. If required, clean in accordance with instructions on page 48. Dry the stainless steel electrode surface for a value of zero (0) to enter as the “LOW” calibration point in the following steps.

5. Perform steps 5 - 11 of the **Conductivity Calibration, Carbon-Graphite Sensor**.

pH CALIBRATION

pH Function Calibration Notes

1. The most common buffers are 4, 7 and 10, but any pH buffers will work if there is at least 3 pH units difference between solutions.

2. Always use two buffers that are most representative of the operating conditions. Example: if monitoring around 8 pH use a 4 buffer for the low point and 10 for the high point.

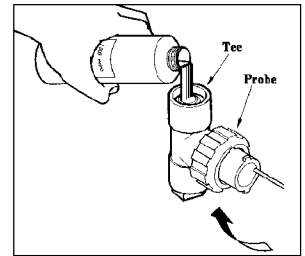

FIGURE 12
Conductivity sensor shown installed in CALKIT tee with deionized water being added.

Main Menu
Display Data

Main Menu
Calibrate Sensor

Calibrate Sensor
sys cond

sys cond calibra
2 point* 3 point

sys cond low calibra
0 us / cm

sys cond hi calibra
XXX us / cm

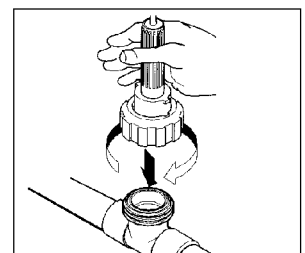

FIGURE 13
Reinstall sensor into flow assembly prior to calibrating, high setting.



NOTE:

Be sure to allow sensor to stabilize for at least 2 minutes each time its environment is changed before evaluating readings.



!!WARNING!!

Care should be exercised when removing the protective rubber boot from the sensor. Submerge the tip of the sensor in water to loosen the protective boot and remove. Save for future storage. Care should also be taken to prevent the glass bulb from hitting the tee or other piping. Never expose the sensor to air with power on for more than 45 seconds. Never allow sensor to dry out.



!!WARNING!!

Sensor must be installed in flow assembly before calibrating High setting if a calkit is not used.

3. Between each sample, rinse sensor with de-ionized water then with next buffer to be sampled.

pH Calibration, 2 point method

1. Obtain a sample of system water and test the sample with a reliable, calibrated pH tester (see figs. 10 and 11, pg. 22). Make note of reading.

2. Close isolation valves and relieve pressure on the system by opening the sample valve. Remove sensor from flow assembly by unscrewing coupling ring. Pull sensor straight up with no side motion to prevent breakage (see fig. 15). Rinse and then inspect sensor. If deposits or fouling is present, clean sensor per instructions in Section 10, Maintenance, pg. 48.

3. (New sensors only) Wet tip of sensor and carefully remove the liquid filled, protective rubber boot from the sensor's tip (see fig. 16). Do not allow sensor's tip to dry out! Save boot for future use.

4. Rinse sensor in pH 4 solution (low cal), then place sensor into a clean container and pour enough pH 4 buffer solution to cover tip (approximately 1" depth) (see fig. 17).

5. Press HOME key until **MAIN MENU-DISPLAY DATA** is displayed. SCROLL DOWN to **MAIN MENU-CALIBRATE SENSOR**. Press ENTER.

6. **CALIBRATE SENSOR** will be displayed on the first line with the sensor to be calibrated on second line. SCROLL DOWN, if necessary, to display **CALIBRATE SENSOR-SYS pH**. Press ENTER.

7. **SYS pH CALIBRA** will be displayed on the first line with **2 POINT** and **3 POINT** on second line. Use ARROW keys to position asterisk (*) next to **2 POINT***. Press ENTER.

8. SCROLL DOWN to display **SYS pH LOW CAL**. Use ARROW keys to input **4.00 pH** and wait two minutes with the entered value flashing. Press ENTER.

9. Rinse sensor in pH 10 solution (Hi cal) then place sensor into a clean container and pour enough pH 10 buffer solution to cover tip (approximately 1" depth). SCROLL DOWN to display **SYS pH HI CAL.** Use ARROW keys to **10.00 pH** and wait two minutes with the entered value flashing. Press ENTER.

Reinstall pH sensor into flow assembly (see fig. 18), close sample valve and slowly open isolation valves.

10. Press HOME repeatedly to return to **MAIN MENU-DISPLAY DATA**. Press ENTER to display data to verify calibration.

ORP CALIBRATION

ORP Function Calibration Notes

1. The most common mV solutions are 100, 465, but any mV calibration solution will work.

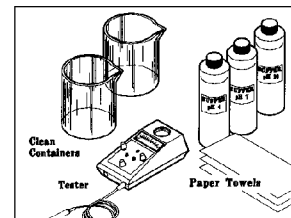

FIGURE 14
Equipment needed for pH sensor calibration.

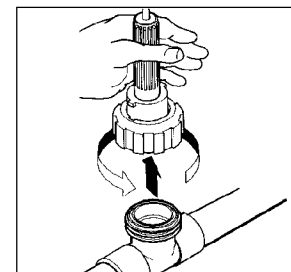

FIGURE 15
Removing pH sensor from flow assembly.

Main Menu
Display Data

Main Menu
Calibrate Sensor

Calibrate Sensor
sys pH

sys pH calibra
2 point* 3 point

sys pH low calibra
4.0 pH

sys pH hi calibra
10 pH

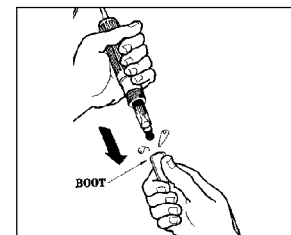

FIGURE 16
Removing protective, liquid-filled, rubber boot from sensor tip.



TIP:

For help with menu locations, please refer to the “Menu Map” supplied with your controller.



NOTE:

Be sure to allow sensor/sensor to stabilize for at least 2 minutes each time its environment is changed before evaluating readings.

2. Between each sample, rinse sensor with mV solution to be sampled.
3. If required, clean sensor before calibration by first flushing with fresh water. Inspect to assure sensor is free of deposits.

ORP Calibration, 2 point method

1. Close isolation valves and relieve pressure on the system by opening the sample valve. Remove sensor from flow assembly by unscrewing coupling ring. Pull sensor straight up with no side motion to prevent breakage (see fig. 15) Inspect sensor, if deposits or fouling is present, clean sensor per instructions in Section 10, Maintenance, pg. 48.
2. Rinse ORP sensor with 100 mV, low buffer solution, then place sensor in a clean container. Pour enough low buffer solution into the container to cover the sensor’s tip (see fig. 17).
3. Press HOME key until **MAIN MENU-DISPLAY DATA** is displayed. **SCROLL DOWN** to **MAIN MENU-CALIBRATE SENSOR**. Press ENTER.
4. **CALIBRATE SENSOR** will be displayed on the first line with the sensor to be calibrated on second line. **SCROLL DOWN**, if necessary, to display **CALIBRATE SENSOR-SYS ORP**. Press ENTER.
5. **SYS ORP CALIBRA** will be displayed on the first line with **2 POINT** and **3 POINT** on second line. Use ARROW keys to position asterisk (*) next to **2 POINT***. Press ENTER.
6. **SCROLL DOWN** to display **SYS ORP LOW CAL**. Use ARROW keys to input **100mV**, the value of the low buffer solution and wait two minutes with the entered value flashing. Press ENTER.
7. Rinse ORP sensor with 465 mV, high buffer solution, then place sensor in a clean container. Pour enough high buffer solution into the container to cover the sensor’s tip (see fig. 17).
8. **SCROLL DOWN** to display **SYS ORP HI CAL..** Use ARROW keys to enter **465 mV**, the value of the high buffer solution and wait two minutes with the entered value flashing. Press ENTER.
9. Reinstall ORP sensor into flow assembly (see fig. 18), close sample valve and open isolation valves.
10. Press HOME repeatedly to return to **MAIN MENU-DISPLAY DATA**. Press ENTER to display data to verify calibration.

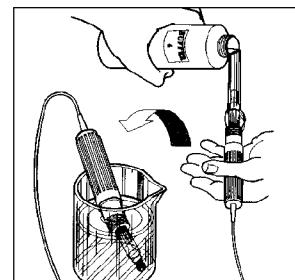

FIGURE 17
Adding pH buffer solution to sensor in a clean container for calibration.

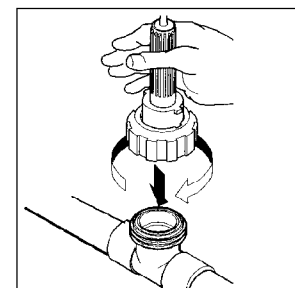

FIGURE 18
Reinstall sensor into flow assembly prior to verifying calibration.

Main Menu Display Data
Main Menu Calibrate Sensor
Calibrate Sensor sys ORP
sys ORP calibra 2 point* 3 point
sys ORP low calibra 100 mv
sys ORP hi calibra 465 mv

6. DIAGRAMS: INSTALLATION, COMPONENT, AND ELECTRICAL

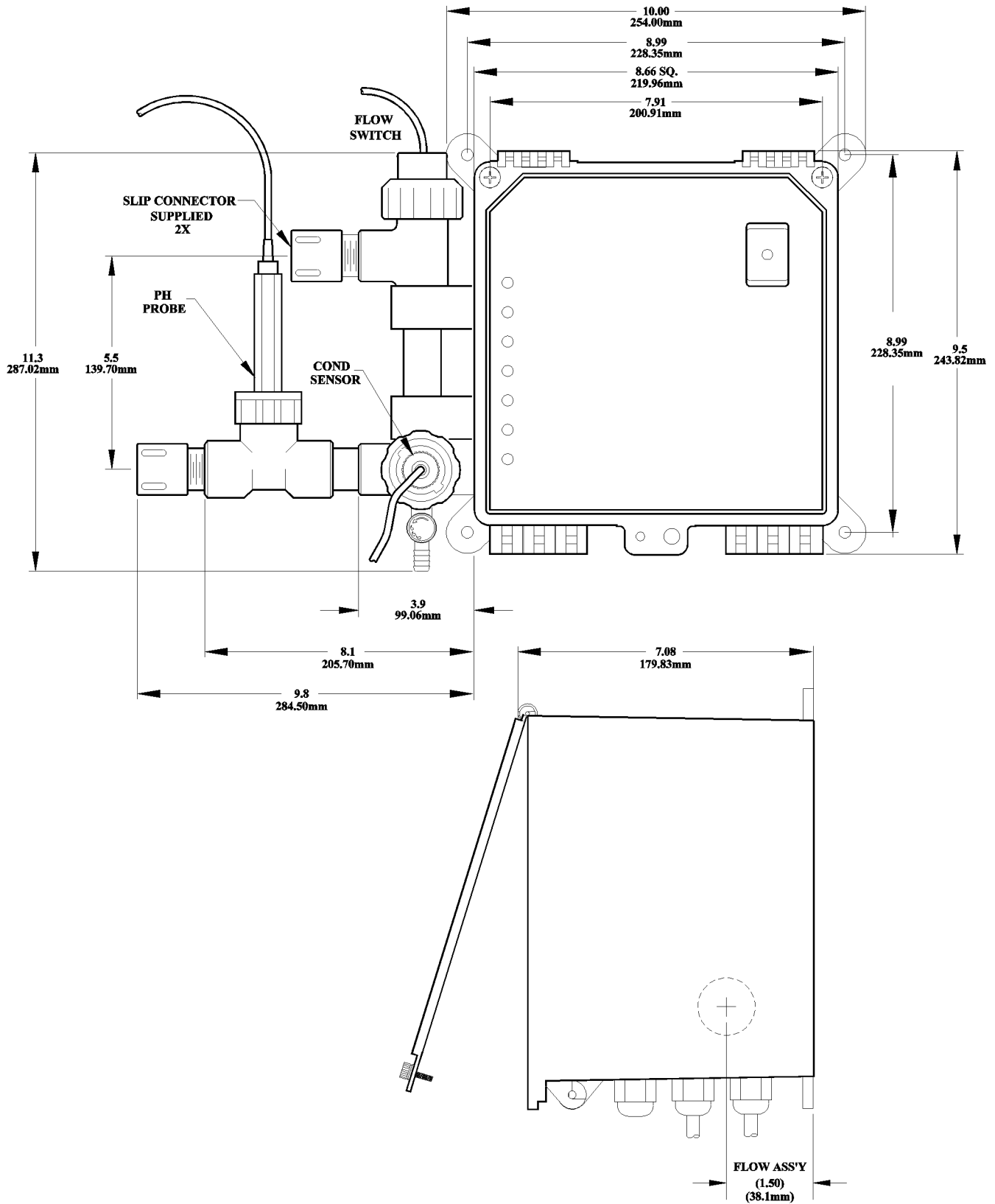
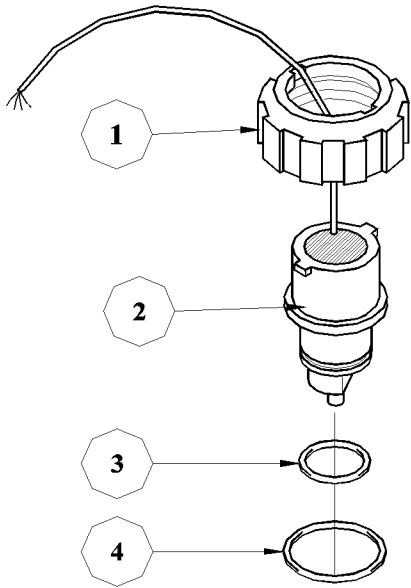

DIAGRAM 1 ENCLOSURE DIMENSIONAL DATA (shown with flow assembly)



**STAINLESS STEEL SENSOR
SPECIFICATIONS**

Pressure Rating125 PSI (8.6 BAR)
 Temperature Rating125° F (51.7° C)
 Temperature Compensation45°F (7.2°C) to 105°F (40.6°C)
 ConstructionGlass Filled Polypropylene Stainless Steel
 Cell Constant 5

WIRE COLOR CODE

RedSensor
 BlackCommon of Sensor and Temperature Compensation
 ClearTemperature Compensation
 (Note: Clear Wire may be Green or White)
 BareShield

MATERIALS

Item 1	Quantity 1	Part No. 06-008-00-E	Coupling Nut
Item 2	Quantity 1	Part No. 04-600-02	Conductivity Sensor Assembly
Item 3	Quantity 1	Part No. 03-005-02-E	Gasket, O-Ring 2-119
Item 4	Quantity 2	Part No. 03-005-04-E	Gasket, O-Ring 2-029

DIAGRAM 2 STAINLESS STEEL SENSOR

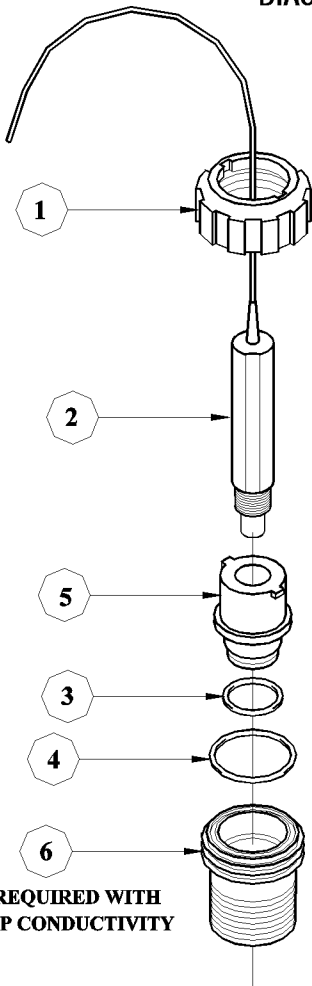

**CARBON GRAPHITE SENSOR
SPECIFICATIONS**

Pressure Rating125 PSI (8.6 BAR)
 Temperature Rating125° F (51.7° C)
 Temperature Compensation45°F (7.2°C) to 105°F (40.6°C)
 ConstructionGlass Filled Polypropylene Carbon Graphite
 Thread Size.....3/4" (19.05mm) NPT
 Cell Constant 1.0

WIRE COLOR CODE

RedSensor
 BlackCommon of Sensor and Temperature Compensation
 ClearTemperature Compensation
 (Note: Clear Wire may be Green or White)
 BareShield

MATERIALS

Item 1	Quantity 1	Part No. 06-008-00-E	Coupling Nut
Item 2	Quantity 1	Part No. 04-035-00	Carbon Graphite Sensor Conductivity
Item 3	Quantity 1	Part No. 03-005-02-E	Gasket O-Ring #2-119
Item 4	Quantity 1	Part No. 03-005-04-E	Gasket O-Ring #2-029
Item 5	Quantity 1	Part No. 03-096-64-E	Sensor Holder
Item 6	Quantity 1	Part No. 03-096-60-E	Insertion Adaptor

**ONLY REQUIRED WITH
MAKE-UP CONDUCTIVITY**

DIAGRAM 2A CARBON GRAPHITE SENSOR

pH

SPECIFICATIONS

Double Junction

pH RangepH 0 to 14 (Na+ < 0.1 N)

Accuracy+/- 0.1 pH Unit

Response Time< 10 Sec. (95% Response)

Operating Temperature Range23 to +176° F
(-5 to +80° C)

Operating Pressure Range.....100 psi

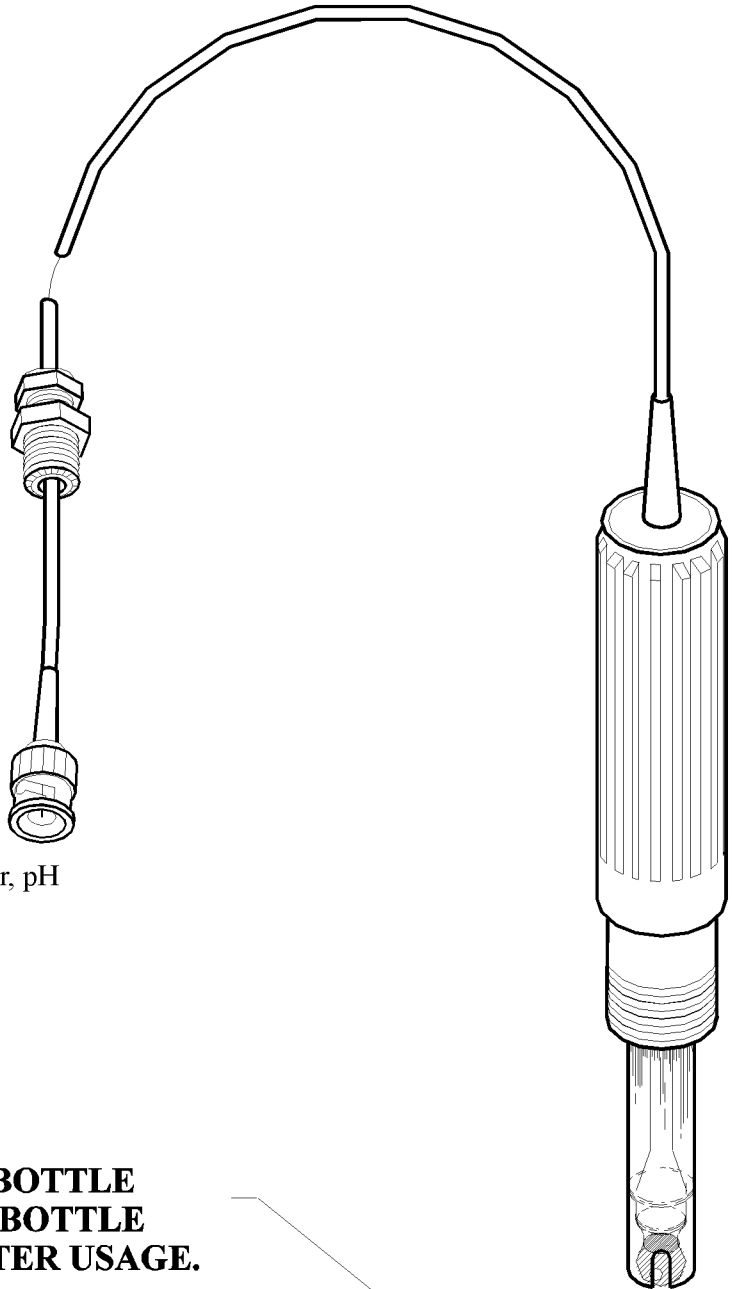

MATERIALS

Item 1 Quantity 1 Part No. 04-040-00 Sensor, pH

IMPORTANT
REMOVE PROTECTIVE BOTTLE
FOR OPERATION, KEEP BOTTLE
IN SAFE PLACE FOR LATER USAGE.

ORP

SPECIFICATIONS

ORP Range0-1000 mV

Response Time< 25 Sec. (95% Response)

Operating Temperature Range ...23 to +176°F (-5 to +80°C)

Operating Pressure Range.....50 psi @ 176°C (80°C),
100 psi @ 77°F (25°C)

Reference Type.....Annular Ceramic

Reference Sensor.....Polysaccharide Gel,

Outer Solution 4 M KCl sat'd with AgCl

MATERIALS

Item 1 Quantity 1 Part No. 04-045-00 Sensor, ORP

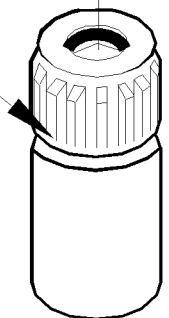
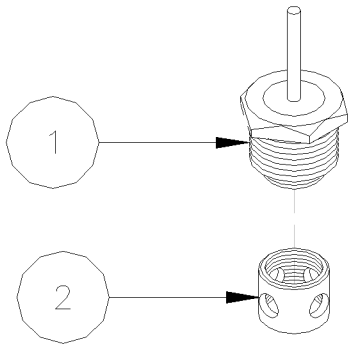

DIAGRAM 3 SENSORS



HI-PRESSURE CONDUCTIVITY SENSOR

SPECIFICATIONS
 Pressure Rating250 PSI (17.3 BAR)
 Temperature Rating32° F to 212° F (0° C to 100° C)
 Temperature Compensation45°F to 105°F (7° C to 40°C)
 ConstructionStainless Steel with CPVS Insulator
 Cell Constant.....1.5

MATERIALS

Item 1	Quantity 1	Part No. 04-600-30	Conductivity Sensor with end cap
Item 2	Quantity 1	Part No. 03-068-00	end cap only

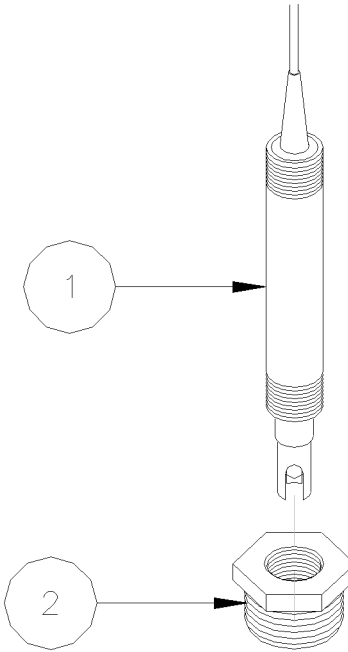

HI-PRESSURE pH SENSOR

SPECIFICATIONS
 pH RangepH 0 to 14 (Na+ < 0.1N)
 Accuracy± 0.1 pH Unit
 Response Time< 10 sec. (95% response)
 Operating Temperature23°F to 215°F (-5°C to 120°C)
 Operating Pressure Rating250 psi (17.3 BAR)

MATERIALS

Item 1	Quantity 1	Part No. 04-048-00	pH Sensor
Item 2	Quantity 1	Part No. 03-135-14	Reducer Bushing

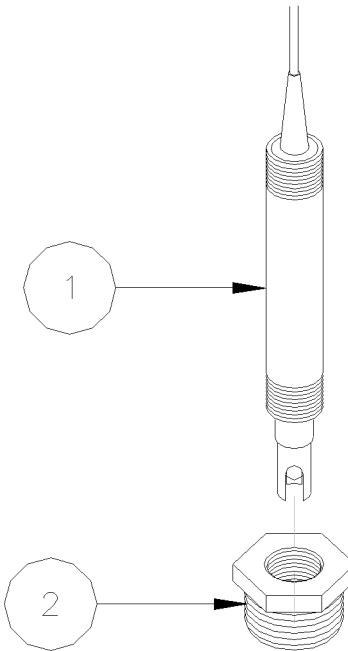

HI-PRESSURE ORP SENSOR

SPECIFICATIONS
 ORP Range± 2000mV
 Response Time< 25 sec. (95% response)
 Operating Temperature23°F to 215°F (-5°C to 120°C)
 Operating Pressure Rating250 psi (17.3 BAR)

MATERIALS

Item 1	Quantity 1	Part No. 04-045-05	ORP Sensor
Item 2	Quantity 1	Part No. 03-135-14	Reducer Bushing

DIAGRAM 3A HI-PRESSURE SENSORS

BY VERSION SHOWN ON FOLLOWING PG.

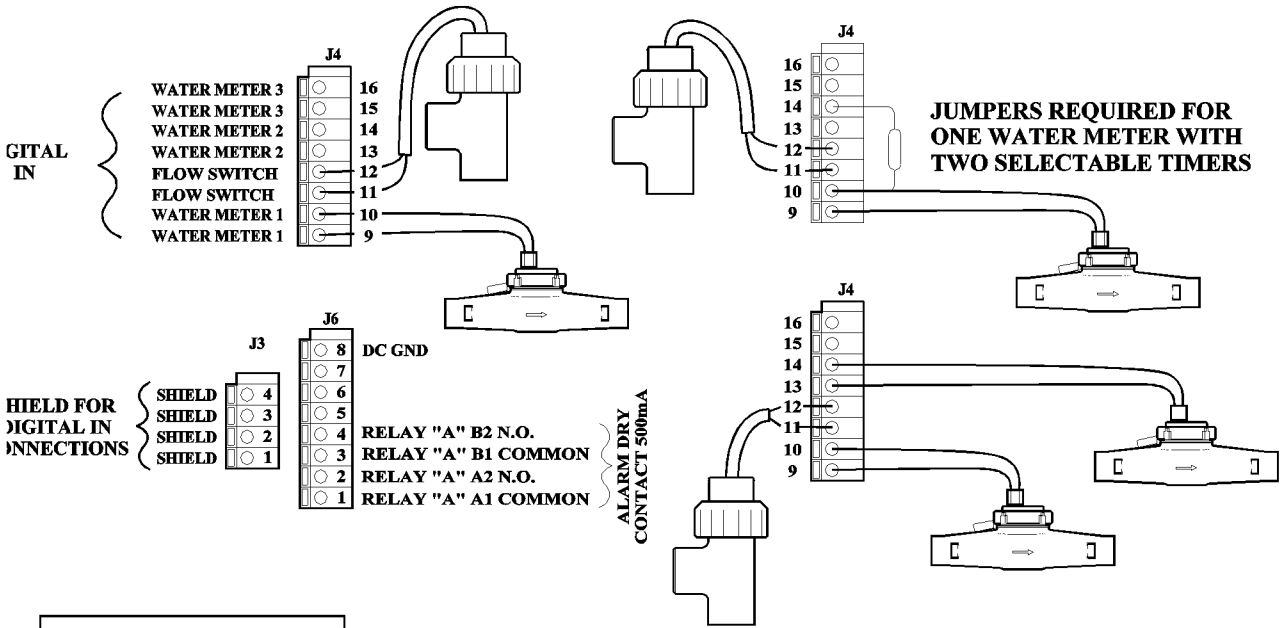

WARNING!
Solid state relays leak a small amount of current (about 10mA at line voltage) even when they are in the off state

AC VOLTAGE CONNECTIONS "J5"

- 1 - BLACK HOT
- 2 - WHITE NEUTRAL
- 3 - GREEN GROUND

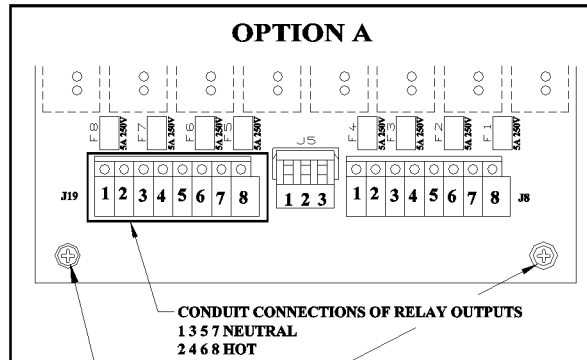
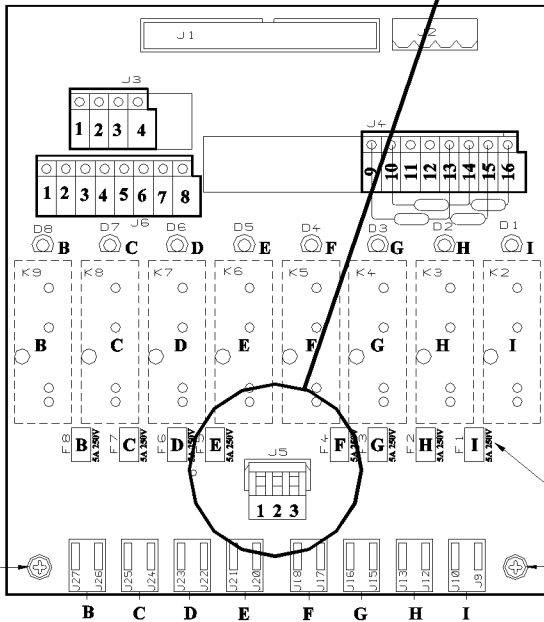
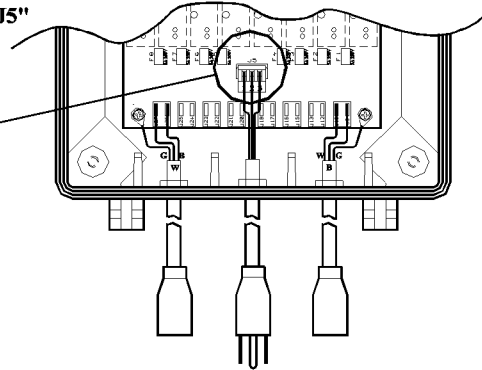

FUSES F1 - F8
**EARTH GROUND SCREW TERMINAL

** GROUNDING HERE REQUIRED FOR ALL POWERED OUTPUTS

DIAGRAM 4 RELAY BOARD

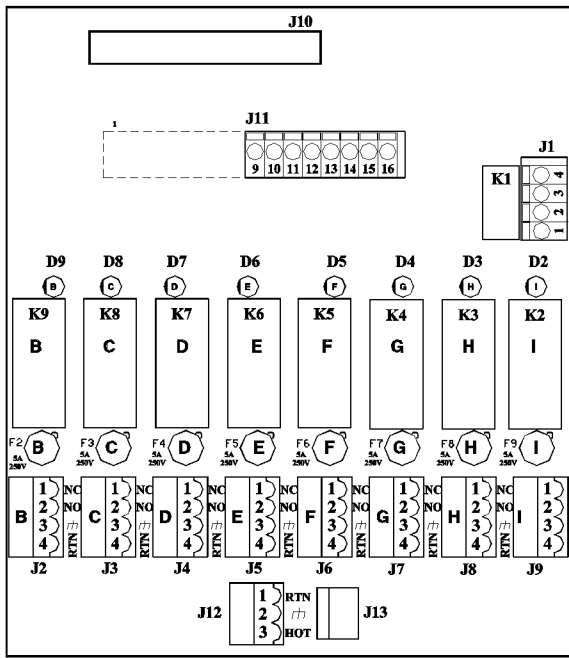

CURRENT VERSION

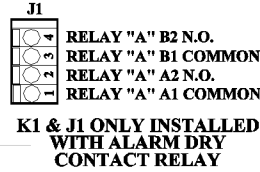

K1 & J1 ONLY INSTALLED WITH ALARM DRY CONTACT RELAY

ALARM DRY CONTACT
500mA

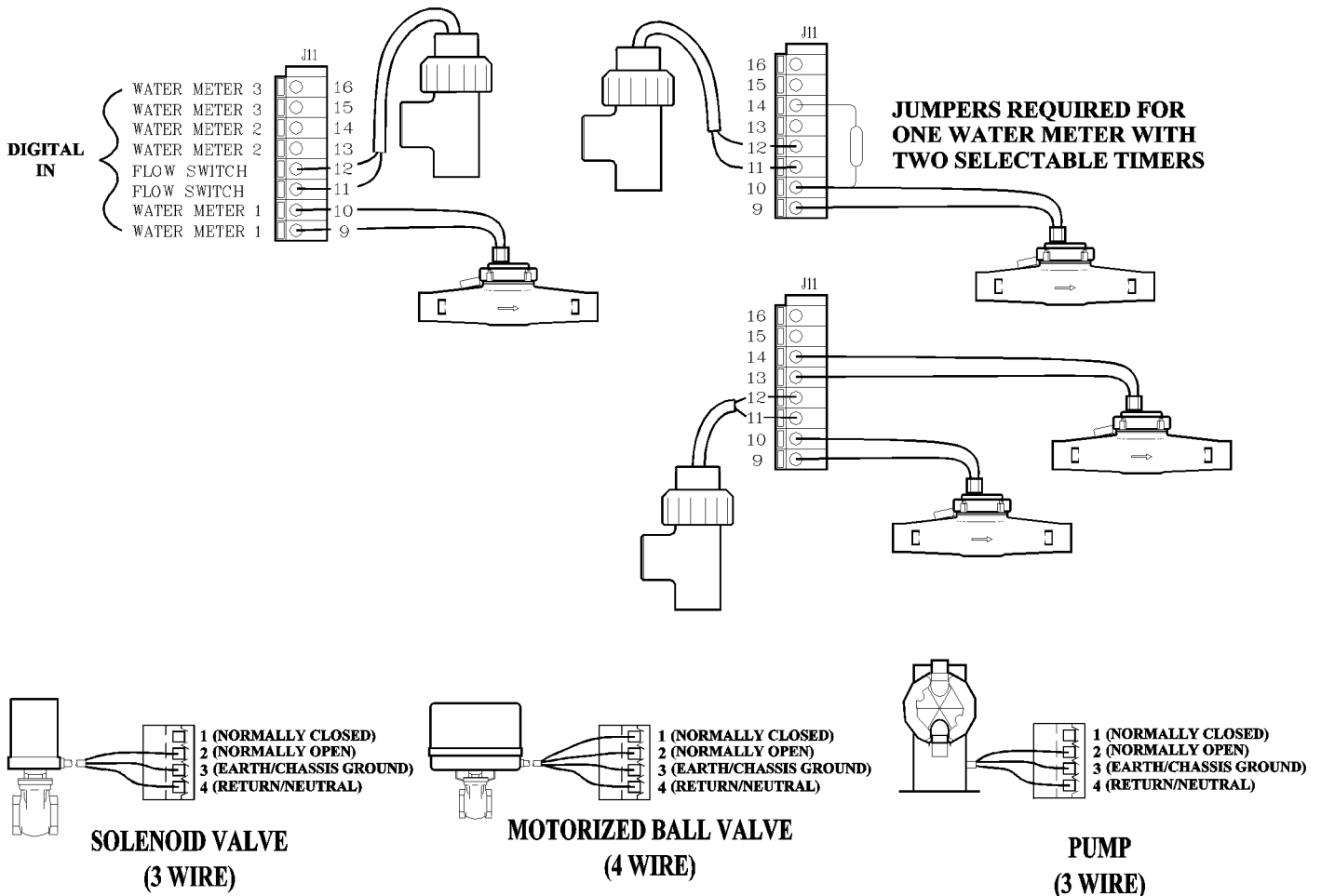
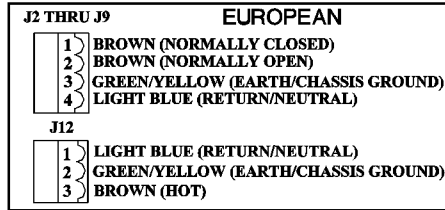
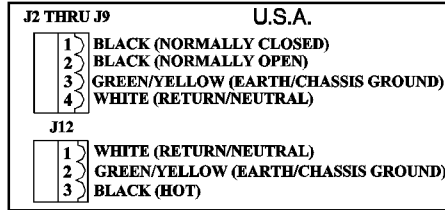
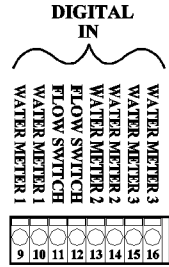
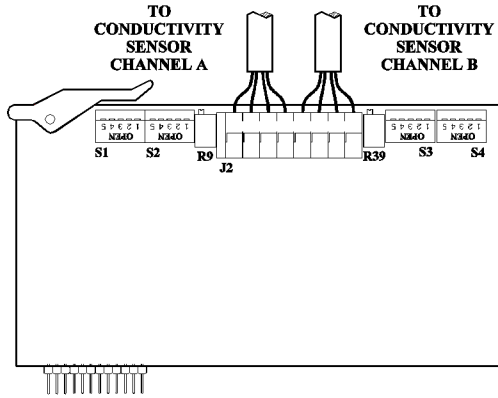

DIAGRAM 4A RELAY BOARD, SAMPLE CONNECTIONS TO PUMP, SOLENOID, & BALL VALVE



SENSOR CABLE WIRE CODE

CHANNEL "A"	CHANNEL "B"
1 - RED	5 - RED
2 - BLACK	6 - BLACK
3 - CLEAR	7 - CLEAR
4 - SHIELD	8 - SHIELD

NOTE: CLEAR WIRE MAY BE GREEN OR WHITE

SWITCH POS.	DESCRIPTION	DEFAULT
S1/S3 1	DISABLES SENSOR TEMP COMP.	OPEN
S1/S3 2	NON-STANDARD SENSOR CALIBRATION	OPEN
S1/S3 3	NO FUNCTION	OPEN
* S1/S3 4	SELECT 1.0 CELL CONSTANT	CLOSED
* S1/S3 5	SELECT 0.5 CELL CONSTANT	OPEN

SWITCH POS.	DESCRIPTION	DEFAULT
S2/S4 1	SELECTS 500 uS/CM SCALE	OPEN
S2/S4 2	SELECTS 2,000 uS/CM SCALE	OPEN
S2/S4 3	SELECTS 5,000 uS/CM SCALE	CLOSED
S2/S4 4	SELECTS 10,000 uS/CM SCALE	OPEN
S2/S4 5	SELECTS 20,000 uS/CM SCALE	OPEN

NOTE: SOFTWARE CONDUCTIVITY RANGES MUST MATCH CARD SETTINGS.

* WHEN EJECTOR IS SO MARKED THE CELL CONSTANTS WILL BE 1.5 & 0.5 RESPECTIVELY.

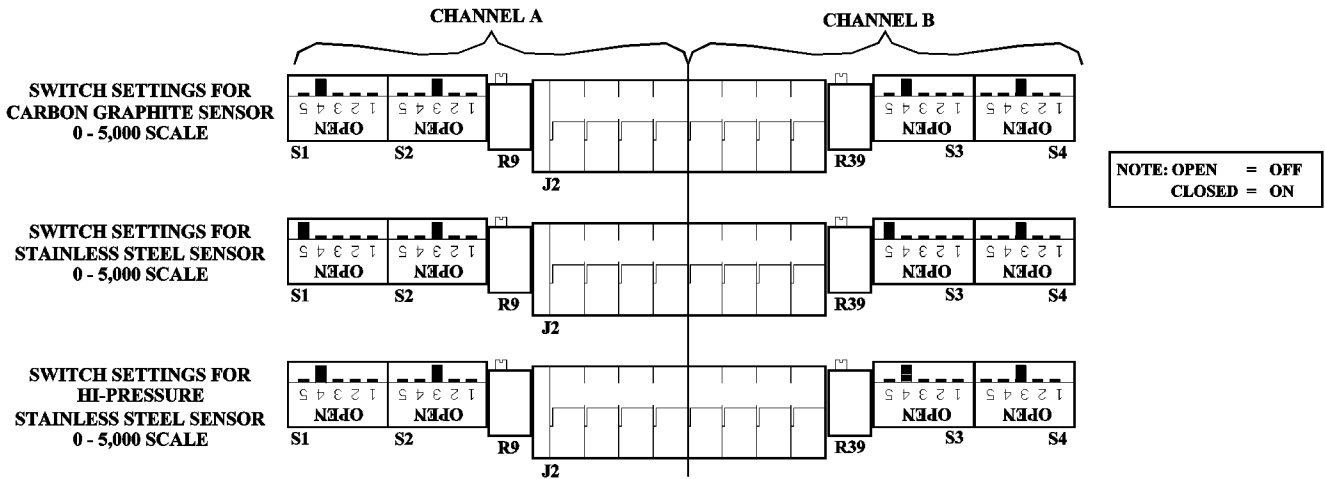

CURRENT VERSION

OBSOLETE VERSION REPLACED BY VERSION SHOWN ABOVE

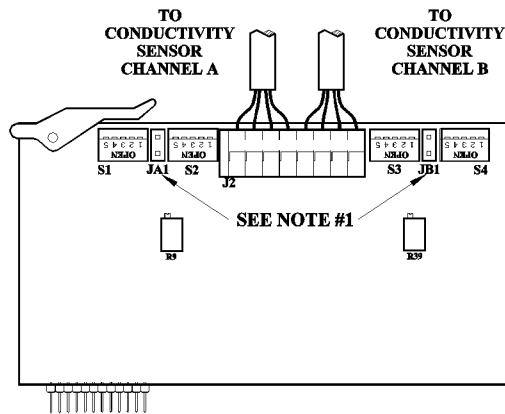

SENSOR CABLE WIRE CODE

CHANNEL "A"	CHANNEL "B"
1 - RED	5 - RED
2 - BLACK	6 - BLACK
3 - CLEAR	7 - CLEAR
4 - SHIELD	8 - SHIELD

NOTE: CLEAR WIRE MAY BE GREEN OR WHITE

CHANNEL A						
SCALE	JA1	S2-1	S2-2	S2-3	S2-4	S2-5
500	NOTE 1	X	OFF	OFF	OFF	OFF
200	NOTE 1	OFF	X	OFF	OFF	OFF
5000	NOTE 1	OFF	OFF	X	OFF	OFF
10000	NOTE 1	OFF	OFF	OFF	X	OFF
20000	NOTE 1	OFF	OFF	OFF	OFF	X

CHANNEL B						
SCALE	JB1	S4-1	S4-2	S4-3	S4-4	S4-5
500	NOTE 1	X	OFF	OFF	OFF	OFF
200	NOTE 1	OFF	X	OFF	OFF	OFF
5000	NOTE 1	OFF	OFF	X	OFF	OFF
10000	NOTE 1	OFF	OFF	OFF	X	OFF
20000	NOTE 1	OFF	OFF	OFF	OFF	X

NOTE 1: JUMPER FOR NON-COMPENSATED SENSOR. REMOVE FOR TEMPERATURE COMPENSATED SENSOR.

2: ALL SWITCHES ON S1/S3 SHOULD BE IN THE OPEN POSITION.

DIAGRAM 5 CONDUCTIVITY DAUGHTER BOARD

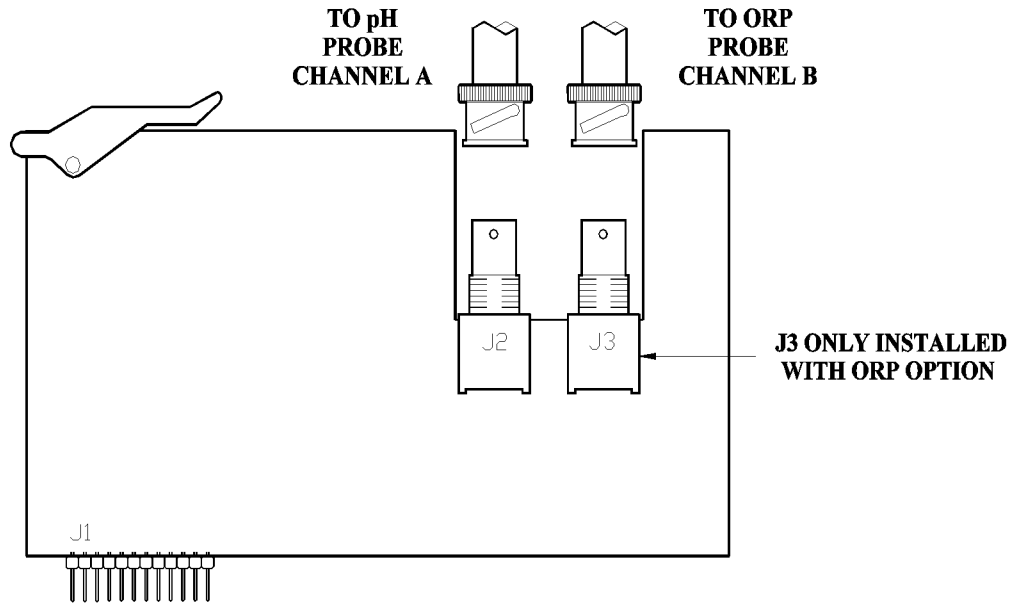

CURRENT VERSION

**OBSOLETE VERSION REPLACED
BY VERSION SHOWN ABOVE**

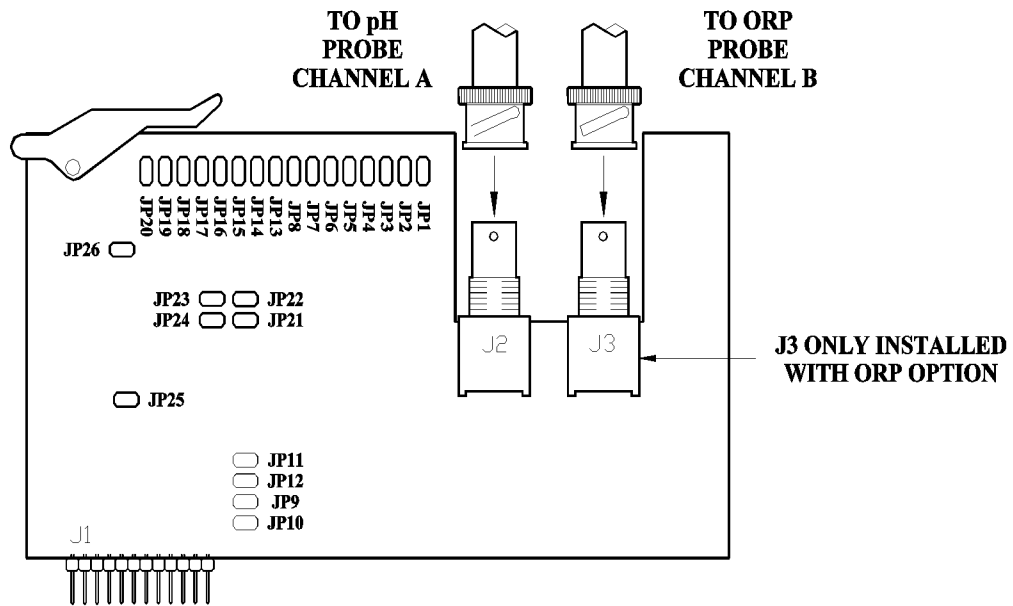

CONFIGURATION	JP1	JP2	JP3	JP4	JP5	JP6	JP7	JP8	JP9	JP10	JP11	JP12	JP25
pH OPERATE					X			X		X		X	X
14pH CAL			X				X			X		X	X
0pH CAL		X					X			X		X	X
7pH CAL				X			X			X		X	X

DIAGRAM 6 PH/ORP DAUGHTER BOARD

ANALOG SIGNAL DAUGHTER BOARD SLOT LOCATIONS, IF CONTROLLER IS SO EQUIPPED

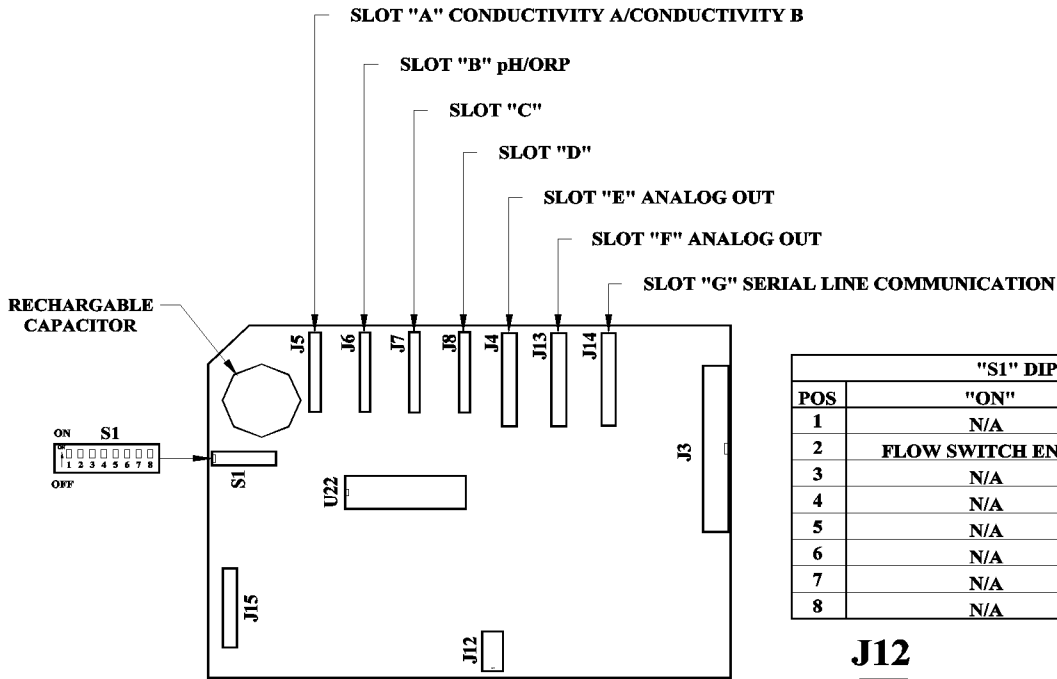

"S1" DIP SWITCH SETTINGS		
POS	"ON"	"OFF"
1	N/A	N/A
2	FLOW SWITCH ENABLE	N/A
3	N/A	N/A
4	N/A	N/A
5	N/A	N/A
6	N/A	N/A
7	N/A	N/A
8	N/A	N/A

J12

- 1 +5VDC
- 2 GROUND
- 3 +12VDC
- 4 GROUND
- 5 -12VDC
- 6 GROUND

CURRENT VERSION

OBSOLETE VERSION REPLACED BY VERSION SHOWN ABOVE

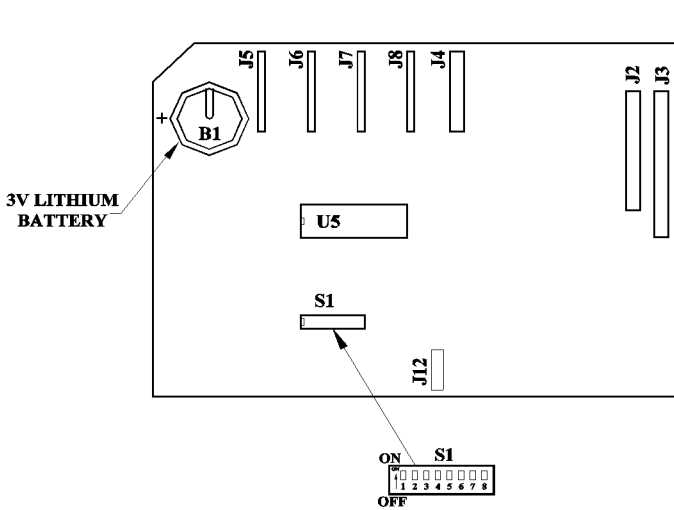

"S1" DIP SWITCH SETTINGS		
POS	"ON"	"OFF"
1	N/A	N/A
2	FLOW SWITCH ENABLE	N/A
3	N/A	N/A
4	N/A	N/A
5	N/A	N/A
6	N/A	N/A
7	DIAGNOSTICS	N/A
8	FACTORY REINIT	N/A

J12

- 1 +5VDC
- 2 GROUND
- 3 +12VDC
- 4 GROUND
- 5 -12VDC
- 6 GROUND

DIAGRAM 7 MOTHER BOARD

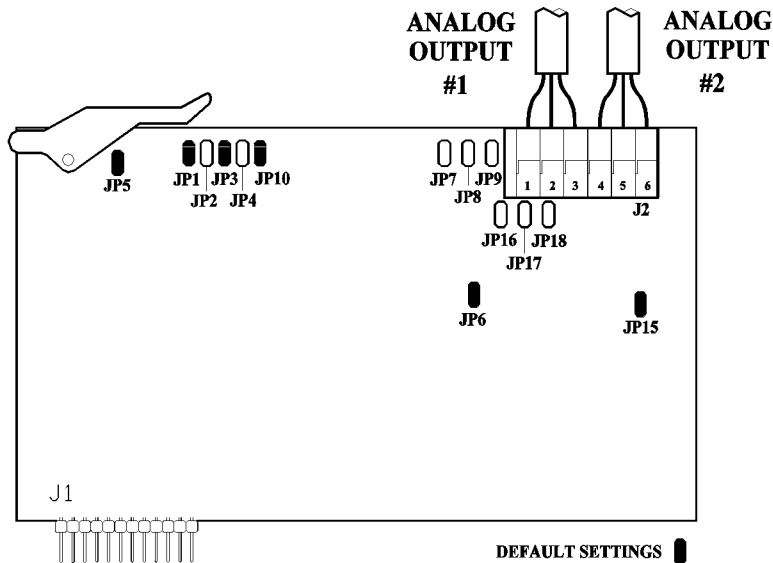

WIRE CODE
 1 - RED (+)
 2 - BLACK (-)
 3 - SHIELD
 4 - RED (+)
 5 - BLACK (-)
 6 - SHIELD

SINGLE CHANNEL (08-600-13)

CHANNEL 1	JP1	JP2	JP5	JP6	JP7	JP8	JP9
0-1mA		X					
0-20mA	X						
*4-20mA	X		X	X			
0-2V	X				X		
0-5V	X					X	
0-10V	X						X

* DEFAULT SETTING

DUAL CHANNEL (08-600-12)

CHANNEL 2	JP3	JP4	JP10	JP15	JP16	JP17	JP18
0-1mA		X					
0-20mA	X						
*4-20mA	X		X	X			
0-2V	X				X		
0-5V	X					X	
0-10V	X						X

* DEFAULT SETTING

CURRENT VERSION

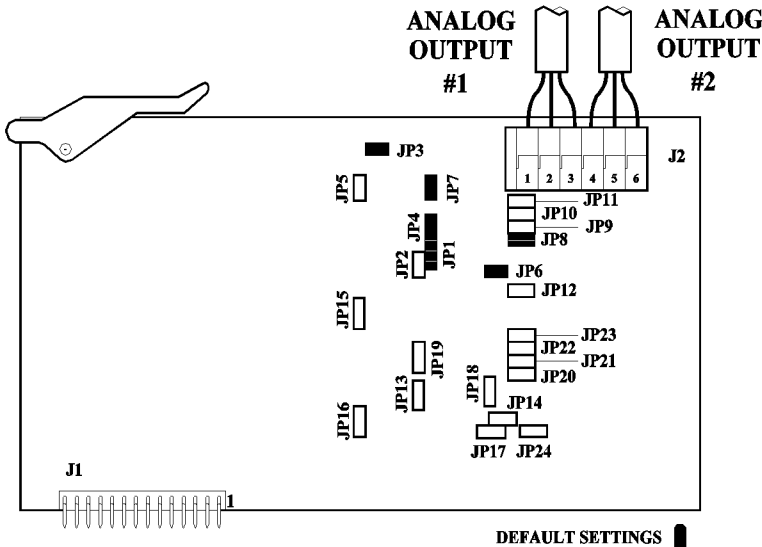

OBSOLETE VERSION REPLACED BY VERSION SHOWN ABOVE

WIRE CODE
 1 - RED (+)
 2 - BLACK (-)
 3 - SHIELD
 4 - RED (+)
 5 - BLACK (-)
 6 - SHIELD

SINGLE CHANNEL (08-600-13) DUAL CHANNEL (08-600-12)

CHANNEL 1	JP1	JP2	JP3	JP4	JP5	JP6	JP7	JP8	JP9	JP10	JP11	JP12
CHANNEL 2	JP13	JP14	JP15	JP16	JP17	JP18	JP19	JP20	JP21	JP22	JP23	JP24
0-1mA			X	X				X				
0-20mA					X		X	X				
*4-20mA	X			X	X	X	X	X				
0-2V	X		X	X					X			X
0-5V	X		X	X						X		X
0-10V	X		X	X							X	X

* DEFAULT SETTING

DIAGRAM 8 DAUGHTER BOARD - ANALOG OUTPUTS

FIELD INSTALLATION OF DAUGHTER BOARD/CABLE ASSY, SERIAL LINE COMMUNICATION WITH OR WITHOUT MODEM

1. Disconnect power to unit at main. Open enclosure and remove power supply cover.
2. Pass Cable through tapped hole "P" in enclosure, if provided. If not, punch out an unused knockout in bottom of enclosure and use Locknut, Item #4 to secure cable. See "Optional Route" in illustration below.
3. Attach Cable to daughter card jack labeled "J2". Insert card in slot closest to hinge.
When inserting card, check the alignment of the pins with the connector.
4. Re-install power supply cover.
5. Check all internal connections and close unit.
6. Insert free plug on cable 2 into either adaptor 4 (direct conn) or adaptor 5 (phone line)
7. Attach adaptor to appropriate interface: 1) The serial port on your PC, or 2) A telephone line jack.
8. Re-connect power at main.

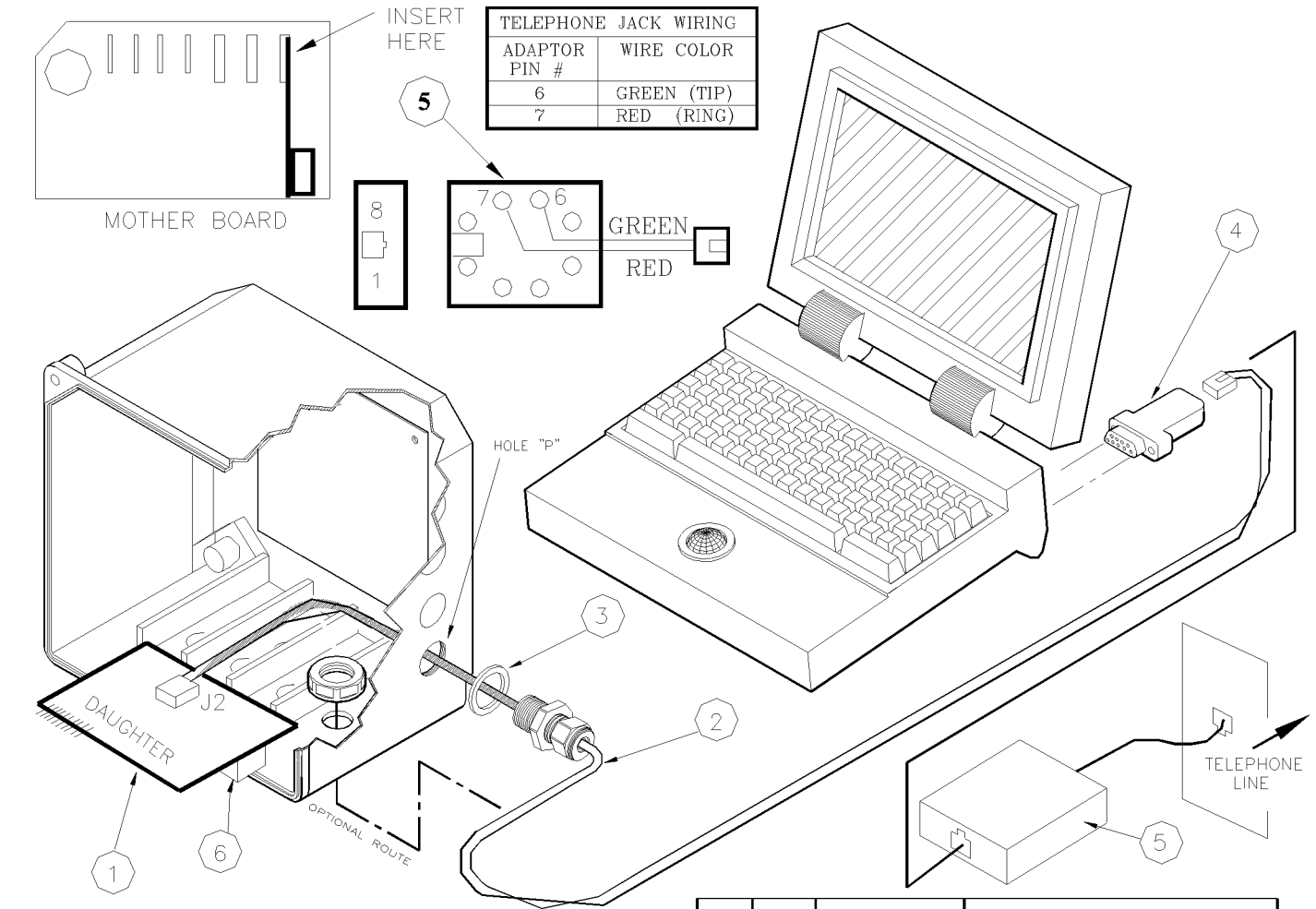

TELEPHONE JACK WIRING	
ADAPTOR PIN #	WIRE COLOR
6	GREEN (TIP)
7	RED (RING)

REF.	ITEM #	PART NUMBER	DESCRIPTION
6		09-019-01 OR 09-019-00	MODEM MODULE, 14.4K BAUD OR MODEM MODULE, 2400 BAUD
1	5	13-079-72	CABLE,PHONE JACK ASSY
1	4	* 06-089-11 AND 06-089-05	DIRECT/CONNECT, 25 PIN (“CE” VERSION ONLY) AND DIRECT/CONNECT, 9 PIN
1	3	03-007-00	RETAINING RING
1	2	13-079-70 OR * 13-079-73	CABLE, 7FT (2.13m) MODEM OR CABLE, “CE” 7FT (2.13m) MODEM
1	1	08-600-43 OR 08-600-45 OR 08-600-48 OR 08-600-49	SERIAL LINE COMM BOARD OR SERIAL LINE COMM BOARD W/MODEM OR SERIAL LINE COMM BOARD OR SERIAL LINE COMM BOARD W/MODEM
QTY	ITEM #	PART NUMBER	DESCRIPTION

* NOT SHOWN

BILL OF MATERIALS

DIAGRAM 9 COMMUNICATION, FIELD INSTALLATION

CABLE* PIN-OUT

* CABLE IS WIRED STRAIGHT THROUGH, PIN #1 TO PIN #1, ETC.

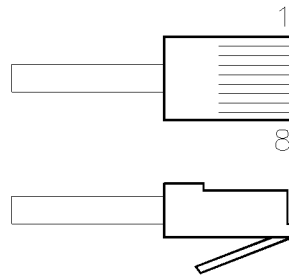

RJ-45	
POS.	POS.
1	ISO GROUND
2	RS-232 IN
3	RS-232 OUT
4	ISO GROUND
5	CTS
6	RING
7	TIP
8	RTS

RJ-45	
POS.	POS.
1	NC
2	NC
3	NC
4	NC
5	NC
6	RING
7	TIP
8	NC

TELEPHONE LINE ADAPTOR

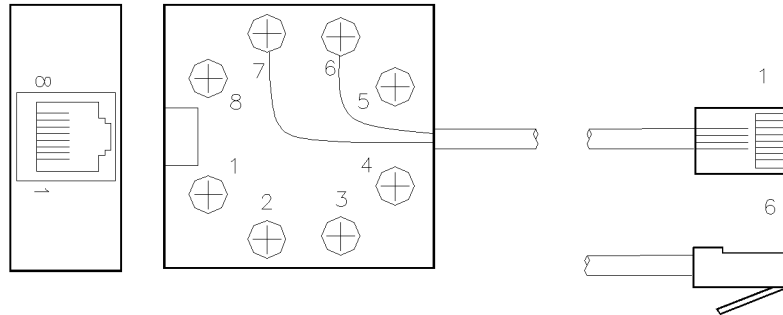

RJ-11	
POS.	POS.
1	NC
2	NC
3	RING
4	TIP
5	NC
6	NC

RJ-45	
POS.	POS.
1	NC
2	RS-232 IN
3	RS-232 OUT
4	ISO GROUND
5	CTS*
6	NC
7	NC
8	RTS*

SERIAL PORT ADAPTOR

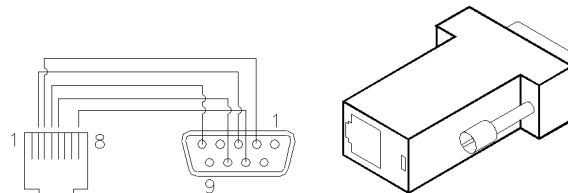

DB-9	
POS.	POS.
1	NC
2	RS-232 OUT
3	RS-232 IN
4	NC
5	ISO GROUND
6	NC
7	RTS
8	CTS
9	NC

* CTS SHORTED TO RTS ON DAUGHTER CARD.

Note:

DO NOT plug the telephone line adaptor into the serial line adaptor

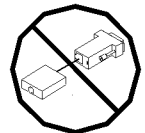

WARNING

DO NOT plug the oversized modular telephone plug into a digital phone system or Local Area Network! You may damage the unit and void the warranty.

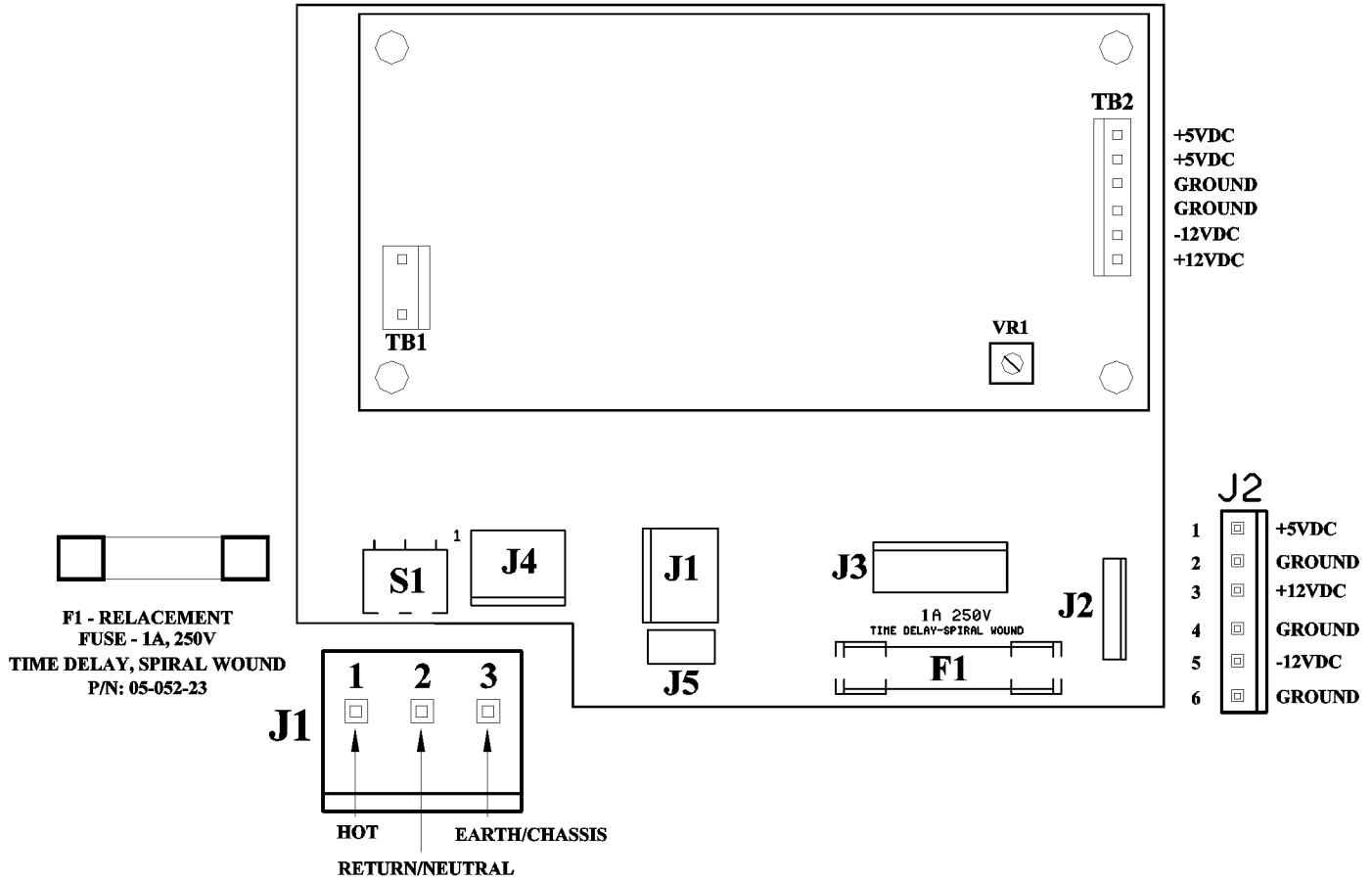

STANDARD VERSION

"CE" VERSION

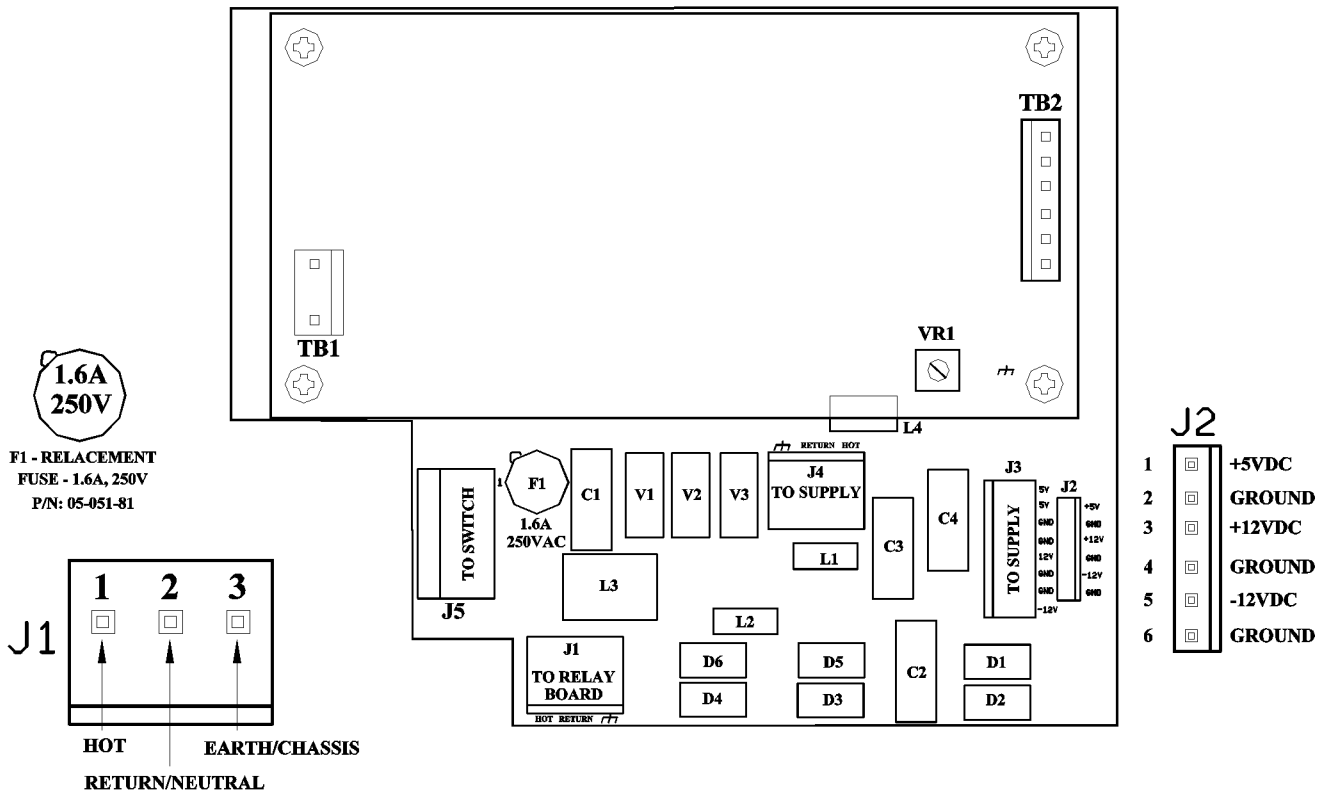

DIAGRAM 10 POWER SUPPLY

7. SPECIFICATIONS

(Factory settings are default values)

GENERAL

Power Input	90/250VAC @ 50/60 Hz 100 VA.
Control Output	Line voltage @ 600 VA (5 amps @ 120 VAC) per relay.
Enclosure Prewired	High impact resistant polystyrene designed to NEMA 4X, with convenient molded receptacle cords and power cord with molded plug for electrical connections.
Enclosure Conduit	High impact resistant polystyrene designed to NEMA 4X, factory predrilled with easily accessible terminals for hard wiring.
Display	Alphanumeric 2 line by 16 character lighted LCD display.
Power Switch	Recessed front panel.
H/O/A Switches	Front panel keypad.
Bilingual	English and Spanish standard.
Lockable Viewing Window	Standard
Security Code	Standard (Configure Menu only)
Environment	Ambient temp. 0°F (-17.8°C) to 125°F (52°C); relative humidity 0 to 100%.
Dimensions	Width 10" (25.40cm) X height 10" (17.78cm) X depth 7.08" (17.98cm)
Controller Weight	8 lbs (3.63 kgs)
Shipping Weight	10 lbs (4.54 kgs)
Flow Switch or Interlock	Connection provided. Function activated by dip switch if mounted flow switch or remote flow switch not ordered with controller.
Inputs	2 analog and 2 digital
Outputs	2 analog and 4 relays
Power Surge	Not protected. Surge suppression required. See Electrical wiring, pg. 7.

CONDUCTIVITY FUNCTION

Sensor	Temperature compensated from 45°F (7.2°C) to 105°F (40.6°C), quick-release 3/4" glass filled polypropylene flow tee. Pressure 125 psi @ 125°F (51.7°C).
Set Point	Select rising or falling. Factory set rising @ 1500 µS/cm.
Range	Selectable 0 to 500, 2000, 5000, 10,000 & 20,000. Factory set @ 5000 µS/cm.
Accuracy	+/- 1% of full scale, at point of measurement, excluding sensor.
Differential	Adjustable. Factory setting @ 100 µS/cm.
High/Low Alarm	Adjustable. Select follow set point or independent set of HIGH and LOW, factory set track set point @ +/- 200 µS/cm.

pH FUNCTION

Sensor	Sealed combination type; KCI-AgCI reference with 3/4" Glass Filled Polypropylene flow tee, 100 psi @ 176°F (80°C).
Set Point	Select rising or falling, factory set rising 7.4 pH.
Accuracy	+/- 1% of full scale at point of measure, excluding sensor.
Differential	Adjustable; factory setting 0.2 pH.
High/Low Alarm	Adjustable. Select follow set point or independent set of HIGH and LOW; factory set follow set point +/- 1 pH.

Limit Timer Adjustable in 1 minute increments up to 24 hours; factory set at 1:30 hr/min.

ORP SPECIFICATIONS

Sensor Sealed combination type; KCl-AgCl reference with 3/4" glass filled polypropylene flow tee; 50 psi @ 176°F (80°C), 100 psi @ 77°F (25°C).

Set Point Select rising or falling, factory set falling 400 mV.

Range 0 to 1000 mV.

Accuracy +/- 1% of full scale, at point of measure, excluding sensor.

Differential Adjustable; factory setting 50 mV.

High/Low Alarm Adjustable. Select track set point (follows set point) or independent set of HIGH and LOW. Factory setting track set point +/- 100.

Limit Timer Adjustable in 1 minute increments up to 23 hours, 59 minutes; factory set at 1:30 hr/min.

SUMMARY OF KEYPAD

Home When pushed, returns display back one level in menu structure.

Enter When pushed, enters displayed variable or value.

Scroll Up Used to scroll-up through (view) menu structure and to display variables.

Scroll Down Used to scroll-down through (view) menu structure.

Contrast Keys Used to control contrast of viewing screen.

Arrow Keys Used to move between variables and to increase/decrease numerical settings.

Language Used to select one of the two onboard languages.

Help Used to display information about present displayed menu level.

Relay Keys Hand/Off/Auto (HOA) switches, depressing key:
ONCE - Forces corresponding output relay on for five minutes;
LED color amber.
TWICE - Forces corresponding output relay off indefinitely;
LED color red.
THREE times - Returns control to automatic;
LED off if within set point, green if out of set point.

SUMMARY OF LED INDICATOR LIGHTS

Power Indicator Illuminates when power is supplied to unit.

Flow Indicator Illuminates when flow is present through flow switch. This indicator will not be functional or labeled if mounted flow assembly was not ordered. User can activate function on site.
GREEN - Indicates flow
RED - Indicates no flow
OFF - Indicates disabled

Alarm Indicator Flashes red when an alarm condition is present.

Relay Indicators AMBER if forced on.
RED if forced off.
OFF if in auto mode and control function is not automatically activated.
GREEN if activated automatically.

8. FACTORY DEFAULT VALUES

NOTE: Your controller may not include all of these features

SYSTEM CONDUCTIVITY SCALE	DEFAULT					
High Alarm	5000 µS/cm					
Low Alarm	1700 µS/cm					
Set Point	1300 µS/cm					
Set Point Differential	1500 µS/cm rising					
Alarm Offset	100 µS/cm					
	200 µS/cm					
SYSTEM pH SCALE	0-14 pH					
High Alarm	9.40 pH					
Low Alarm	5.40 pH					
Set Point	7.40 pH rising					
Set Point Differential	0.20 pH					
Alarm Offset	2.00 pH					
Limit Timer	01:30 HH:MM					
SYSTEM ORP SCALE	0-1000 mV					
High Alarm	500 mV					
Low Alarm	300 mV					
Set Point	400 mV falling					
Set Point Differential	50 mV					
Alarm Offset	100 mV					
MAKE-UP CONDUCTIVITY SCALE	2000 µS/cm					
High Alarm	700 µS/cm					
Low Alarm	500 µS/cm					
Set Point Differential	0.40 Cycles					
INHIBITOR TIMER	Limit					
Feed Timer	10:00 HH:MM					
BIOCIDE TIMERS						
Week	No Week					
Day	Friday					
Start Time	00:00 HH:MM					
Run Time	01:30 HH:MM					
Bleed Lock Out Time	00:00 HH:MM					
Pre-Blowdown Time	00:00 HH:MM					
Conductivity Min	0 µS/cm					
MISCELLANEOUS						
Hi/Low Alarms	Tracking Set Point					
Display Dampener	1 Second					
POSSIBLE ALARMS						
All High Alarms	X					
All Low Alarms	X					
Limit Time pH	X					
Limit Time ORP	X					
No Flow	X					
Inhibitor Limit Timers	X					
OTHER INHIBITOR FEED MODES						
PULSE TIMER						
Run Time	00:30 MM:SS					
Accumulator Set	10					
Count Totalizer	1					
PERCENT TIMER						
Percent On	0%					
% of Minutes	10					
% OF POST BLOWDOWN						
% of Blowdown Feed	0%					
OTHER SCALES	Max Range	High Alarm	Low Alarm	Set Point	Set Pt. Diff.	Alarm Offset
0-500	500	200	100	150	20	50
0-2000	2000	700	500	600	40	100
0-10000	10000	3300	2700	3000	150	300
0-20000	20000	6600	5400	6000	200	600

9. TROUBLESHOOTING GUIDE

If your controller is not operating properly, proceed through the troubleshooting instructions below.

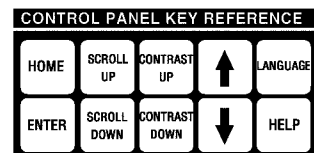

MOTHER BOARD

Symptom	Probable Cause	Isolation and Resolution
Keypad Locked Up	In process of changing conductivity scale.	Scroll down or scroll up after 15 seconds.
No Display (See Power Supply first)	Improper contrast	Adjust on control panel with Contrast Up/Down keys.
	Environment exceeds 122°F (50°C)	Relocate controller.
	Connection loose or not made from mother board to display.	Press on front panel around display. Remove mother board and re-connect display.
	No power to mother board.	Check power supply cable connectors are tight and properly aligned. Check power supply. See power troubleshooting section.
	Failed display.	Replace display.
Display Garbled	Loose connections.	Press front panel around display, or remove mother board and re-connect.
	Power supply voltage out of specification.	Refer to power supply troubleshooting section.
	Power applied to digital input.	Disconnect ribbon cable from relay board to mother board—check inputs with volt meter.
	Mother board failure.	Run diagnostics. Hold language key while cycling power on controller. Replace mother board and software.
	Bad EPROM.	Replace EPROM.
	Power surge.	Factory re-initialize.
	4-20 mA outputs card attached to input supplying loop power.	Isolate input
Display too dark or light.	Contrast changes due to temperature fluctuation.	Adjust contrast.
Display backlit, but not working.	Power supply voltage out of specification	Refer to power supply troubleshooting section.
	Mother board/EPROM failure.	Re-initialize. Replace mother board.
Erratic Readings	Improperly grounded power	Assure power and ground integrity. Shields of all sensors should be connected at controller end only. Verify proper earth grounding.
Flow Light Never Activates (Green indicates ON, Red indicates OFF)	Function not activated	TURN POWER OFF! Turn switch S1-"2" on mother board ON. See Diagram 7, pg. 34. TURN POWER ON.
Flow Light Stays On (Green) in No Flow Condition.	Flow switch stuck up.	Clean flow sensor (see page 49).
	Flow switch cap bad.	Check for wire integrity or replace flow cap. Check relay board positions 11 and 12 on J4 (pg. 30) or J11 (pg. 31) for installed jumper.

Flow Light does not come On (Green) in Flow Condition

- Flow switch dirty or stuck down.
- Inadequate flow.
- Bad shuttle.
- Bad flow cap.
- Wiring loose or incorrect.

- Clean flow switch assembly.
- Increase flow. One GPM minimum.
- Replace shuttle. Refer to maintenance on page 48.
- Replace cap.
- Check flow switch wiring connections on relay board. Refer to pages 30 and 31.

POWER SUPPLY BOARD

Symptom	Probable Cause	Isolation and Resolution
No Power Light	Power switch off	Turn power switch ON.
	Blown fuse	Replace fuse on Power Supply board.
	No power supplied	Check power source.
	Interconnecting cables loose	Check connections.

Use the Following Procedure to Diagnose Power Related Problems:

**CAUTION—
MAINS VOLTAGE
WILL EXIST AT
THE CONNEC-
TIONS YOU TEST!**

1. Check power at source (into relay board at J12 [previous version J5] Phoenix connector), if power is there, proceed. If not, check supply power.
2. Check for power to the power supply at J7 on relay board. If power is there, proceed. If not, replace relay board.
3. Check power after the wire cable from J7 to the power supply (see Diagram 10, pg. 38). If power is there, proceed. If not, replace cable.
4. Check fuse on power supply. If okay, proceed. If not, replace fuse or power supply.
5. Check voltages at output of power supply (see Diagram 10, pg. 38). If okay, proceed. If not, check power switch is turned on. If still no voltage, replace power supply.
6. Check voltages at mother board (see Diagram 7, pg. 34). If okay, proceed. If not, check and/or replace power supply to mother board cable.
7. If voltage exists at mother board, but you have no display or lights on the front panel, refer to Mother Board section of trouble shooting guide.

RELAY BOARD

Symptom	Probable Cause	Isolation and Resolution
No Outputs NOTE: Each relay, on the Relay Board, has a fuse and a red LED	If the Output front panel LED is lit and the Relay board LED is not lit: • ribbon cable.	Check ribbon cable between mother board and relay for good connection. Replace if necessary.
	If the Output front panel LED is lit and the Relay board LED is also lit: • blown fuse • bad relay	Replace fuse, if necessary, or replace relay
	If the Output front panel (relay) LED is not lit and the Flow LED is red.	Check for flow and flow switch.
	No Flow	Relays are forced off with loss of flow (configuration dependent).
	Limit timers exceeded.	Interrupt flow, satisfy condition or cycle power.

COOLING TOWER CONDUCTIVITY

Symptom	Probable Cause	Isolation and Resolution
Front Panel Blowdown LED Stays On	Conductivity of water is above set point, blowdown restricted.	Check blowdown line and do one of the following: <ul style="list-style-type: none"> • Clean strainer. • Clean solenoid. • Replace solenoid.
	Treatment chemicals or process liquid at sensor.	Check sample stream injection of treatment chemicals/process liquid at sensor. Injection should be down stream.
	Conductivity of sample stream higher than system conductivity, sample stream restricted.	Check for flow in sample stream and do one of the following: <ul style="list-style-type: none"> • Clean strainer. • Clean sample line.
	Make up controlling conductivity set point number below system set point.	Check cycles setting. Adjust if required. Normal occurrence.
Conductivity of Controller Decreases While System Conductivity Increases	Fouled sensor.	Clean sensor. Refer to Section 10, pages 48 and 49.
Conductivity of System Stays Lower Than Set Point, Never Or Rarely Blows Down	Uncontrolled blowdown.	Close manual blowdown valve. Fix leaks in cooling system. Blowdown valve leaking. Do one of the following: <ul style="list-style-type: none"> • Realign ball valve; if leaking by the ball valve. • Clean solenoid valve; if leaking by the solenoid valve.
Conductivity Reading Drifts Lower than Sample Tested	Probe fouled. Calibrations procedure not carefully followed.	Clean sensor. Re-calibrate. Perform calibration. Follow stabilization time cautions. If decrease continues, necessitating frequent cleanings.
	Calibration point not near set point.	Re-calibrate with solution near set point
Front Panel Blowdown LED Cycles On and Off	Air in sample line	Bleed air off. Close isolation valves. Loosen flow switch to bleed. Re-tighten before opening valves.
	Differential (dead band) too tight	Widen differential. Check solenoid location (piping).
Controller Not Blowing Down With High Conductivity	Biocide locking out bleed.	Wait for programmed biocide activation to end. Normal behavior.
	No flow	Check flow switch and flow.
	Relay bad or fuse bad.	Check relay and fuse.
Conductivity Blowing Down with Conductivity Below Set Point	Set point differential not satisfied.	Check settings and readings.
	Biocide pre-bleed activated.	Normal
	Cycles of concentration default settings calls for it (make up sensor only).	Check settings and readings.
	Controller on Falling set point	Correct to Rising set point in configure menu.

NOTE: A zero or low makeup conductivity reading will cause cycles to sky rocket! Refer to conductivity section of troubleshooting.

Chemical Pump Not Activating	Pulse Timer: <ul style="list-style-type: none"> • Check for flow through water meter • Check water meter contacts • Check wiring from controller 	Renew flow. Replace water meter register. Replace wiring.
Drift	Dirty electrode. Improper calibration Chemical coating of stainless steel sensors Air bubbles or turbulence Conductivity wiring is not correct. Hardware scale settings do not match scale selected in program. Jumpers on conductivity daughter card. Serial line is improperly wired with ground connected at unit and at modem.	Clean sensor Review procedures Do calibration without cleaning the sensor. Change to Carbon Graphite style. Review plumbing set-up. Check wire integrity on conductivity card. Check switch settings on daughter cards and scale in software section. See Diagram 5, page 32. Make sure conductivity card S1/S3-1 is open for a temperature compensated sensor. Closed for a non-temperature compensated sensor. See Diagram 5, page 32. Check wiring.
Conductivity is 0	Scale settings incorrect or no scale switch selected. Air lock. Corroded sensor Wiring connections loose. Improper calibration. Bad sensor or daughter card or mother board.	Check switch settings on daughter card and scale in software selection. See Diagram 5, page 32 Review plumbing. Replace. Check and rewire if necessary, sensor connection on conductivity board. Review procedures. See Section 5, page 22. Perform the following sequence to determine which is faulty: <ol style="list-style-type: none"> 1. Short across the electrode. This should give a full scale reading(e.g. 20,000). If it does, sensor, daughter card and mother board are probably good. 2. If not, short across red and black wire input terminals at daughter card. Should give a full scale deflection. If it does, daughter card and mother board are probably good and the problem is in the sensor or sensor cable.
Conductivity Reading Does Not Change After Calibrating	No flow by sensor. Sensor wires reversed. Reading is over scale selected. Failed temperature compensation network in the sensor. Shorted sensor.	Check flow and flow switch. Check wiring integrity. See Diagram 5, page 32. Change to a higher scale. Check sensor. See procedure at end of this section (page 46). Replace sensor Replace sensor or check wiring.
Conductivity Changes During Hook-up	Serial line direct hook-up exceeds 50' (15.25 m). Serial line integrity damaged.	Out of spec. use modem for over 50'. Replace wiring or cord.

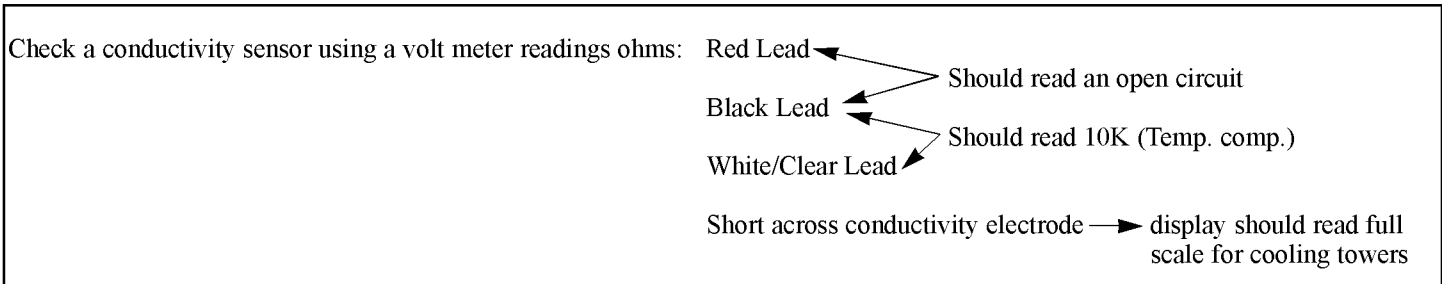

COOLING TOWER pH

Symptom	Probable Cause	Isolation and Resolution
Inability To Calibrate pH	Fouled pH sensor	Clean sensor. Refer to Section 10, page 48.
	Faulty pH sensor	Replace sensor.
	Incorrect calibration	Review procedures. Refer to Section 5, page 23.
Front Panel pH Feed LED Off And: • pH Above Rising Set Point • pH Below Falling Set Point	Limit timer timed out	Reset timers. Turn system power off and on, or satisfy the conditions for control. Interrupt flow through flow assembly if installed. Verify: pump setting chemical drum level Check for leaks.
	Restriction in sample line	Check for flow in sample stream and: • Clean strainer. • Flush sample line.
	Pump lost prime Chemical drum empty	Prime pump. Replenish chemical supply. Reset Timer: 1) Interrupt flow through flow assembly if installed 2) Satisfy the condition by manually feeding, etc.
pH Does Not Change after Calibrating or goes to 14	Bad sensor.	Replace sensor.
	Bad connection on the BNC cable.	Check by shorting BNC connection at daughter card(short center lead to outer case). If it does not display 7 on display screen, replace daughter card. If it does, replace sensor.
	Sensor disconnected.	Connect sensor.

LIMIT TIMER

Symptom	Probable Cause	Isolation and Resolution
Inhibitor Timer Does Not Activate	No flow.	Restore flow.
	Improper settings	Check inhibitor feed mode selection.
	No water meter input	Check meter and wiring.
	Blowdown locked out during biocide feed.	Wait for biocide to finish.
	Limit timer exceeded.	Reset by interrupting flow, satisfying the condition, or cycling power.

Improper settings.

Check mode selection.

No Output for a Particular Function

Limit timer exceeded.

Interrupt flow if flow switch included. Cycle power or satisfy control parameters.

TIME, SETTINGS, HISTORY

Symptom	Probable Cause	Isolation and Resolution
Inability to keep Time/Date/Settings/History	Line power spikes	Provide spike protector and uninterrupted power supply.
	Software failure	Replace EPROM
	Hardware failure	Replace Mother Board
	Improper wiring creating ground loop interference	Check all power wiring including relays and digital inputs. Refer to power supply troubleshooting section and pages 30 and 31.
	Experiencing data changes with brownouts when it falls below 90V	Perform factory Re-Init located in Configure menu. Install surge suppressor. Refer to page 7

REINITIALIZATION

If the above troubleshooting steps fail to explain or solve condition, perform a factory reinitialization (see Initialization, pg.9). If condition still exists, contact factory for customer service assistance. A Return Authorization (RA) number is required for any return.

10. MAINTENANCE

The only maintenance required on these controllers is periodic cleaning and calibration of the sensors. It is recommended that you establish a regular maintenance schedule designed to meet the needs of your particular application. All other service should be performed by factory authorized personnel only. Modifications to or tampering with the circuit level components makes all warranties, written or implied, and/or manufacturer's responsibility for this controller null and void.

CONDUCTIVITY SENSOR REMOVAL AND CLEANING

To remove the conductivity sensor from its tee for cleaning:

1. Remove power from the system.
2. Remove pressure from the system prior to unscrewing the sensor; to remove pressure, close hand valves located before and after flow assembly.
3. Open the sample port; this will facilitate removal of sensor.
4. Unscrew the coupling nut.
5. Remove the sensor. If necessary, assure slot on nut and tabs on sensor or sensor holder are NOT lined up (see cleaning instructions below).

To re-install the conductivity sensor:

1. Reinsert the sensor (some conductivity sensors are keyed).
2. Hand tighten nut.
3. Close sample port.
4. Reapply pressure and flow by opening hand valves slowly to avoid water hammer.
5. Reapply power to the system.

To clean the Stainless Steel conductivity sensor:

1. Wipe the sensors with a clean cloth.
2. Use a fine grain emery cloth for stubborn stains.
3. Some fouled sensors might require dipping in a mild solution of muriatic acid in order to remove fouling.
4. Oils can affect sensor performance. Do not touch sensor surface. The sensor can be agitated in a mild solution of dish washing soap and water to remove oils transferred during handling.

To clean the Carbon Graphite sensor:

1. Immerse sensor in a solution of water and mild detergent. When a stronger cleaning solution is required use concentrated hydrochloric acid mixed into 50% isopropanol.
2. Rinse the cell several times with distilled or deionized water.

pH SENSOR INFORMATION

The combination pH sensor supplied with your controller is designed for maximum reliability, accuracy, and ease of use. The reference half-cell is sealed and non-refillable. The sensor is shipped with a protective boot filled with a junction wetting agent.

A) Preparation

Remove the lower portion of the protective boot and rinse the sensor tip with tap water. It is possible that air bubbles may have migrated into the pH sensitive bulb during shipment. The sensor is unable to function with air in the bulb. To remove air, gently shake the sensor downward in the same manner as a clinical thermometer. Prior to first usage or after long-term storage, immerse the lower end of the sensor in tap water for thirty minutes. This hydrates the pH bulb and prepares the liquid junction for contact with the test solution.

Occasionally during long-term storage or shipment, the sensor may develop a film on the pH bulb. The film may be removed by following sensor cleaning instructions.

B) Sensor Storage

To maintain response, sensors should always remain wet. The preferred storage solution is pH 4.0 buffer with saturated KCl added. Tap water will suffice for short term storage. NOTE: Do not soak in distilled water. The storage boot will provide an ideal chamber for lengthy storage.



!!WARNING!!

Use proper handling procedures including rubber gloves, eye protection and protective clothing, when handling any acid solution.

C) Sensor Cleaning

Sensors which are mechanically intact can often be restored to full response by the following procedures:

1. **Inorganic Scale Deposits.** Dissolve the deposit by immersing the sensor first in 0.1M HCl (hydrochloric acid), then in 0.1M NaOH (sodium hydroxide), and again in 0.1M HCl. Each immersion should be for a 5-minute period.
2. **Organic Oil or Grease Films.** Wash sensor tip in a liquid detergent and water. If film is known to be soluble in a particular organic solvent, wash with this solvent. Rinse sensor tip in tap water.

If these procedures fail to rejuvenate the sensor, the problem is most likely a clogged liquid junction. Cleaning the liquid junction involves heating a diluted KCl (Potassium Chloride) solution to 60-80°C (139 - 176°F). Place sensor tip in the heated KCl solution for approximately ten minutes. Allow the sensor to cool while immersed in the solution before re-testing. If these steps fail to improve the sensor response, replace the sensor.

ORP SENSOR INFORMATION

The ORP option provides monitoring and control with a control set point in millivolts (mV).

ORP Maintenance and Troubleshooting

ORP standard buffers of 100mV and 465mV are readily available, making it easy to standardize ORP systems against buffers. Like pH sensors, ORP sensors are subjected to coating and abrasion by the measured liquid and, in certain instances, are “poisoned” by chemicals which may be present if the system goes out of control. To improve the reliability of ORP measurement and control, the following is a means of testing sensors in solutions of standard potential, which will determine if sensors are responding correctly or need maintenance attention.

Testing ORP Sensor

SOLUTION A: Use sufficient 100mV buffer to immerse sensors. Potential should be within +/- 10.

SOLUTION B: Remove sensors and rinse thoroughly with water. Immerse sensors in 465mV solution. There should be a rapid response.

The millivolt difference between the two solutions is theoretically 365mV. The absolute values may shift upward or downward a few millivolts due to slight variations from theoretical potential by the reference sensor.

If system potentials are correct, flush sensors with deionized water and measure the liquid in question. If incorrect by more than 10 mV, sensors should be cleaned with aqua regia (three volumes hydrochloric acid, one volume concentrated nitric acid.) Repeat above tests. Once satisfactory readings are obtained, install sensors and make measurements of liquid in question.

FLOW SENSOR

The flow sensor uses differential pressure to cause a shuttle to rise and magnetically activate a reed switch. Occasionally this assembly may become fouled, preventing the shuttle from rising and/or falling.

To clean the assembly:

1. Close isolation valves and relieve system pressure from flow assembly.
2. Remove flow cap by loosening retaining nut. Remove flow cap from flow body by pulling straight out.
3. Remove red shuttle by pulling straight out. Note post shuttle rides on.
4. Clean all internal surfaces of flow body with soft bristle bottle brush. Be careful of post that shuttle rides on, its surfaces must be clean, but do not break it while cleaning.
5. Clean shuttle exterior surfaces and shuttle bore with a soft brush. You may use a mild dish soap if desired. Flush well before re-installing.
6. Re-install shuttle and attach flow cap. Open isolation valves. Check for leaks.



!!WARNING!!

Use proper handling procedures including rubber gloves, eye protection and protective clothing, when handling any acid solution.

11. GLOSSARY

- Alarm Relay** an electric circuit when triggered by a predetermined signal will activate an externally connected alarm
- Analog** a device that represents in terms of physical variables, i.e. conductivity, pH, ORP
- Analog Recorder** a device such as a plotter that physically stores or presents quantities of data in a physical manner
- Auto Scroll** a function of the Controller which allows unit to automatically display system status, active alarms, time, date, etc.
- Biocide** an agent used to control the growth of algae and other organic substances
- Bleed** (or blowdown) to release cooling tower water from the system, used to control conductivity
- Blowdown** see Bleed
- Blowdown Valve** the valve that opens or closes to release water from the system activated by a signal from the Controller
- Buffer Solution** a solution with a specific pH value used as a control in calibrating sensors and sensors
- Calibration** a procedure to match values “read” by sensors and sensors to actual real world values
- CalKit** a kit available from the manufacturer with a specific cavity volume used to calibrate conductivity sensor
- Caustic** burning, corrosive, a characteristic of some chemicals especially strong alkalis
- Chattering** a situation that occurs when relay controlled device repeatedly turns off and on
- Chemical Feed Pump** a relay or proportionally controlled pump that disperses chemical into the system
- Chemical Metering Pump** see Chemical Feed Pump
- Conductivity** the ability of a substance to conduct electrical current, concentrations of dissolved and suspended matter in cooling tower water directly determine the conductivity of the water
- Conduit** hard wired
- Configure** procedure to set up basic functions of the controller, i.e. date, time, set point control, etc.
- Contacting head water meter** a water meter that outputs a dry contact signal every time it pulses
- Contrast** difference in brightness between adjacent objects, i.e., darkness of text in screen display versus lightness of the screen background
- Cooling Tower** a structure of various sizes that allows heat to radiate away from the system water.
- Cycle Timer** a timing device that can be preset to turn off and on at specific intervals
- Daughter Board** an auxiliary circuit board within the controller dedicated to a specific function(s) of the controller
- Differential** also referred to as dead band or hysteresis, this is a range or offset applied to a set point value (see chattering)
- Dip Switch** very small switches located on the circuit boards usually used in combination with other dip switch settings
- Display Dampener** a setting in the System Configure menu that determines the number of samples that are averaged and the number of seconds before a new reading is displayed on the screen
- Double Junction** type of construction on a pH sensor
- Dry Contact** relay contacts without power
- EEPROM** Electrically Erasable Programmable Only Memory
- Electrodes** the metal protrusions that measure conductivity in the conductivity sensor assembly
- Fish Paper** thin paper that is inserted between battery and battery clip to prevent battery drain during shipping or storage of controller
- Float Switch** a mechanical switch that shuts off fresh water supply to the cooling tower system when water level rises to a predetermined height
- Flow** refers to the movement of water through the system
- Flow Assembly** an option which attaches to the controller and incorporates a flow switch, sensor/sensor ports, and sample valve
- Gate Valve** a type of on/off valve for controlling the flow of liquid
- GFPPPL** Glass Filled Polypropylene
- Ground Loops** unwanted stray electrical signals that adversely affect controller
- Heat Exchanger** a mechanical device which produces energy and is cooled by the flow of water in the cooling tower system
- HCl** Hydrochloric Acid
- Hi Lo Alarm** a function of the controller that signals the user when conditions exceed a predetermined high or low value
- History Files** information that is stored in the controller, (history files are lost if battery fails or is removed)
- HOA** abbreviation for Hands Off Auto
- HOA Switches** manual relay switches or keys (relay 1 - 6) located on the control panel of the controller
- Home** this key when pressed returns user to the previous menu displayed on the viewing screen, press repeatedly to return to the main menu
- Independent Set Point** this feature, when selected under HI LO ALARM in the System Configure menu, allows user to independently set the high and low alarm values
- Inhibitor** a chemical or compound used to aid the control of corrosion or scaling in the cooling tower system
- Inhibitor Feed** term referring to the dispersment of inhibitor in to the system
- Inhibitor Timer** a function of the controller which regulates the amount of time inhibitor is introduced to the system
- Initialization** a procedure to set up the starting condition of the controller
- Inorganic Scale Deposits** undesirable precipitate formations within the cooling tower system
- Inputs** receptacles or hookups for signals delivered to the controller

- (ISO) Isolation Valves** general term which refers to valves in the system used to isolate various components of the system from the main flow
- Jumper** a wire connector (shunt) that connects two points
- KCl** Potassium Chloride
- LED** abbreviation for Light Emitting Diode
- Limit Timer** also referred to as lockout timer or feed limit timer, it limits the amount of time output is activated
- Line Voltage** voltage equivalent to outside source voltage to the controller
- Lockout** intentionally preventing blowdown or other functions of the system
- Menu Map** printed document supplied with controller illustrating all menu item locations
- Metering Pump** see chemical feed pump
- Micro Siemens** unit of measure of conductivity expressed as uS/cm
- Mother Board** main circuit board located in controller
- NaOH** Sodium Hydroxide
- ORP** Oxidation Reduction Potential, measured in milliVolts (mV) to detect and control level of chlorine or other oxidizing agents in system water
- Outputs** receptacles or hookups for signals originated at the controller
- Overfeed** a condition in which the quantity of an ingredient dispersed into the system exceeds the amount desired
- Percent Post Blowdown** refers to the amount of time as a percentage of blowdown time that chemical feed pumps are activated when blowdown is deactivated
- Percent Timer** also referred to as a cycle timer that runs continuously that activates an output to run as a percent of total cycle time
- pH** the measurement of acidity or alkalinity (acid or base) of an aqueous solution
- Pre-Bleed** refers to the time bleed (or blowdown) is executed before biocide feed
- Pre-Blowdown** see Pre-Bleed
- Program Parameters** the user programmed settings that determine how the controller responds to the conditions of the cooling tower water
- Pulse** the action of a water meter that when equipped with a contact head, can generate a signal sent to the controller
- Pulse Timer** a feature of the controller in which a timer accepts pulses from a water meter to actuate a chemical feed pump
- Relay Board** a circuit board in the controller for relay outputs, water meter hookups, flow switch, etc.
- Relay Indicators** lights (LEDs) located beneath the relay keys on the face of the control panel that indicates the status of individual relays
- Sample Cock** see Sample Valve
- Sample Line** a line within the cooling tower flow where sensors and other monitoring devices are located controlled with isolation valves
- Sample Stream Flow Assembly** an option (standard on many models) which is a modular assembly that mounts to the controller with quick-release sensor(s), flow switch and sample cock or (valve)
- Sample Valve** small valve on the flow assembly that provides user a means to drain small quantities of water from the system for testing
- Scale/Range** the adjustable monitoring range of the controller in reference to conductivity levels in the system
- Security Code** a code that can be entered by the user when configuring the system to secure access to the controller settings
- Sensor** a device connected to the controller which monitors or measures a value in the cooling tower flow stream
- Sensorless Calibration** a calibration procedure used to test and verify operation of the controller
- Set Point** the user determined value within a monitored range at which the controller initiates action
- Set Point Differential** also referred to as dead band or hysteresis; the offset applied to a set point to prevent chattering of an output relay around a set point
- Solenoid** an electromagnetically controlled switch
- Storage Boot** small protective rubber boot filled with a junction wetting agent found on the tip of a new pH or ORP sensor to keep tip wet during shipment and storage
- System Overfeed** usually a malfunction condition where a feed pump fails shut off
- System Parameters** see program parameters
- System pH** level of pH in the system water
- TDS** abbreviation for Total Dissolved Solids, measured in terms of electrical conductivity(uS/cm)
- Temperature Compensation** displays conductivity as if measured at 77°F (25°C)
- Temp Sensor** used to measure temperature, not currently available
- Throttling** the act of adjusting a valve or other flow control device to vary flow volume
- Totalizer** a resettable function of the controller which keeps count of the number of water meter pulses
- Track Set Point** a function of the controller in which set point offset range is determined by set point value
- uS/cm** micro Siemens
- Water Hammer** a potentially damaging situation that occurs if a valve in the system is opened too quickly, where the action results in a “hammering” effect throughout the system water lines
- Y-Strainer** inline filter or screen to remove debris from system flow assembly

12. ADDITIONAL CALIBRATION TECHNIQUES

Conductivity Calibration, 3-point method

Sensors: Carbon-Graphite, Platinum Black

1. Remove the conductivity sensor, refer to Section 5 Conductivity Calibration for instructions..
2. Install sensor into the CALKIT tee (see fig. 19). Rinse with and then refill with Low Cal solution.
3. Press HOME key until **MAIN MENU-DISPLAY DATA** is displayed. SCROLL DOWN to **MAIN MENU-CALIBRATE SENSOR**. Press ENTER.
4. **CALIBRATE SENSOR** will be displayed on the first line with the sensor to be calibrated on second line. SCROLL DOWN, if necessary, to display **CALIBRATE SENSOR-SYS COND**. Press ENTER.
5. **SYS COND CALIBRA** will be displayed on the first line with **2 POINT** and **3 POINT** on second line. Use ARROW keys to position asterisk (*) next to **3 POINT***. Press ENTER.
6. SCROLL DOWN to display **SYS COND LOW CAL**. Use ARROW keys to enter **0** (if using distilled or deionized water for the “Low Cal” solution) or enter the $\mu\text{S}/\text{CM}$ value of the Low Cal solution and wait two minutes with the entered value flashing. Press ENTER.
7. Discard the Low Cal solution. Rinse and refill with the Mid Cal solution.
8. SCROLL DOWN to display **SYS COND MID CAL**. Use ARROW keys to enter the $\mu\text{S}/\text{CM}$ value (**XXX**) of the Mid Cal solution and wait two minutes with the entered value flashing. Press ENTER.
9. Discard the Mid Cal solution. Rinse and refill with the High Cal solution.
10. SCROLL DOWN to display **SYS COND HI CAL**. Use ARROW keys to enter the $\mu\text{S}/\text{CM}$ value (**XXX**) of the Hi Cal solution and wait two minutes with the entered value flashing. Press ENTER.
11. Discard High Cal solution. Reinstall conductivity sensor into flow assembly, close sample valve and slowly open isolation valves. Press HOME repeatedly to return to **MAIN MENU-DISPLAY DATA**. Press ENTER to display data to verify calibration.

pH Calibration, 3-point method

1. Close isolation valves and relieve pressure on the system by opening the sample valve. Remove sensor from flow assembly by unscrewing coupling ring. Pull sensor straight up with no side motion to prevent breakage (see fig. 20.) Inspect sensor, if deposits or fouling is present, clean sensor per instructions in Section 10, Maintenance, pg. 48.
2. Press HOME key until **MAIN MENU-DISPLAY DATA** is displayed. SCROLL DOWN to **MAIN MENU-CALIBRATE SENSOR**. Press ENTER.
3. **CALIBRATE SENSOR** will be displayed on the first line with the sensor to be calibrated on second line. SCROLL DOWN, if necessary, to display **CALIBRATE SENSOR-SYS pH**. Press ENTER.



NOTE:

Be sure to allow sensor to stabilize for at least 2 minutes each time its environment is changed before evaluating readings.

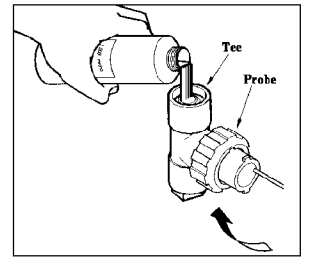

FIGURE 19
Conductivity sensor shown installed in CALKIT tee with deionized water being added.

Main Menu
Display Data

Main Menu
Calibrate Sensor

Calibrate Sensor
sys cond

sys cond calibra
2 point *3 point

sys cond low cal
0 us / cm

sys cond mid cal
XXX us / cm

sys cond hi cal
XXX us / cm

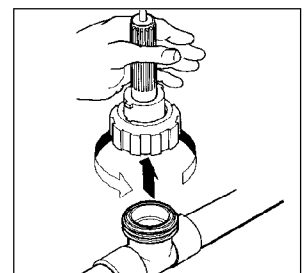

FIGURE 20
Removing pH sensor from flow assembly.

4. **SYS pH CALIBRA** will be displayed on the first line with **2 POINT** and **3 POINT** on second line. Use **ARROW** keys to position asterisk (*) next to **3 POINT***. Press **ENTER**.
5. Rinse pH sensor with low buffer solution then place sensor in a clean container. Pour enough low buffer solution into the container to cover the sensor's tip (approximately 1") (see fig. 21.)
6. **SCROLL DOWN** to display **SYS pH LOW CAL**. Use **ARROW** keys to enter pH **4.0** value of the low buffer solution and wait two minutes with the entered value flashing. Press **ENTER**.
7. Discard the low buffer solution. Rinse pH sensor with mid buffer solution then place sensor in a clean container. Pour enough mid buffer solution into the container to cover the sensor's tip (see fig. 21.)
8. **SCROLL DOWN** to display **SYS pH MID CAL**. Use **ARROW** keys to enter pH **7.0** value of the mid buffer solution and wait two minutes with the entered value flashing. Press **ENTER**.
9. Discard the mid buffer solution. Rinse pH sensor with high buffer solution then place sensor in a clean container. Pour enough high buffer solution into the container to cover the sensor's tip (approximately 1") (see fig. 21.)
10. **SCROLL DOWN** to display **SYS pH HI CAL**. Use **ARROW** keys to enter pH **10.0** value of the high buffer solution and wait two minutes with the entered value flashing. Press **ENTER**.
11. Discard high buffer solution. Reinstall pH sensor into flow assembly (see fig. 22), close sample valve and open isolation valves. Press **HOME** repeatedly to return to **MAIN MENU-DISPLAY DATA**. Press **ENTER** to display data to verify calibration.

ORP Calibration, 3-point method

1. Close isolation valves and relieve pressure on the system by opening the sample valve. Remove sensor from flow assembly by unscrewing coupling ring. Pull sensor straight up with no side motion to prevent breakage (see fig. 20) Inspect sensor, if deposits or fouling is present, clean sensor per instructions in Section 10, Maintenance, pg. 48.
2. Rinse ORP sensor with 100 mV, low buffer solution, then place sensor in a clean container. Pour enough low buffer solution into the container to cover the sensor's tip (see fig. 21).
3. Press **HOME** key until **MAIN MENU-DISPLAY DATA** is displayed. **SCROLL DOWN** to **MAIN MENU-CALIBRATE SENSOR**. Press **ENTER**.
4. **CALIBRATE SENSOR** will be displayed on the first line with the sensor to be calibrated on second line. **SCROLL DOWN**, if necessary, to display **CALIBRATE SENSOR-SYS ORP**. Press **ENTER**.
5. **SYS ORP CALIBRA** will be displayed on the first line with **2 POINT** and **3 POINT** on second line. Use **ARROW** keys to position asterisk (*) next to **3 POINT***. Press **ENTER**.
6. Rinse ORP sensor with low buffer solution then place sensor in a clean container. Pour enough low buffer solution into the container to cover the sensor's tip (approximately 1") (see fig. 21).
7. **SCROLL DOWN** to display **SYS ORP LOW CAL**. Use **ARROW** keys to enter the mV value of the low buffer solution and wait two minutes with the entered value flashing. Press **ENTER**.



NOTE:

Be sure to allow sensor to stabilize for at least 2 minutes each time its environment is changed before evaluating readings.

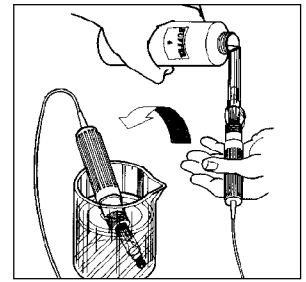

FIGURE 21
Adding pH buffer solution to sensor in a clean container for calibration.

```
sys pH calibra
2 point      *3 point
```

```
sys pH low cal
              4.0 pH
```

```
sys pH mid cal
              7.0 pH
```

```
sys pH hi cal
              10.0 pH
```

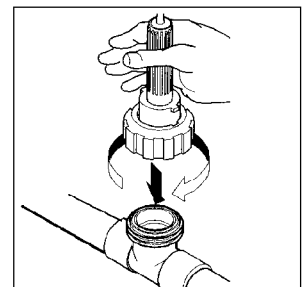

FIGURE 22
Reinstall sensor into flow assembly prior to verifying calibration.

```
Main Menu
Display Data
```

```
Main Menu
Calibrate Sensor
```

```
Calibrate Sensor
sys ORP
```

```
sys ORP calibra
2 point      *3 point
```

```
sys ORP low calibra
              0 mv
```

8. Discard the low buffer solution. Rinse ORP sensor with mid buffer solution then place sensor in a clean container. Pour enough mid buffer solution into the container to cover the sensor's tip (approximately 1") (see fig. 21).

9. **SCROLL DOWN** to display **SYS ORP MID CAL**. Use **ARROW** keys to enter the mV value of the mid buffer solution and wait two minutes with the entered value flashing. Press **ENTER**.

sys ORP mid calibra 0 mv

10. Discard the mid buffer solution. Rinse ORP sensor with high buffer solution then place sensor in a clean container. Pour enough high buffer solution into the container to cover the sensor's tip (approximately 1") (see fig. 21).

11. **SCROLL DOWN** to display **SYS ORP HI CAL**. Use **ARROW** keys to enter the mV value of the high buffer solution and wait two minutes with the entered value flashing. Press **ENTER**.

sys ORP hi calibra 0 mv

12. Discard high buffer solution. Reinstall ORP sensor into flow assembly, close sample valve and open isolation valves (see fig. 18). Press **HOME** repeatedly to return to **MAIN MENU-DISPLAY DATA**. Press **ENTER** to display data to verify calibration.

13. MAKE-UP CONDUCTIVITY

If your controller is equipped with make-up, the blowdown valve is controlled by a set point that is based on the make-up water conductivity.

SENSOR CONNECTIONS

The make-up conductivity sensor is wired to channel B on the conductivity daughter board (see Diagram 5, page 32).

MENU STRUCTURE

NOTE: For help with menu locations, refer to the laminated "Menu Map" supplied with your controller.

The following menu changes are included:

A) Main Menu/Display Data

Includes make-up conductivity reading, scale, cycles of concentration setting.

B) Main Menu/Calibrate Sensor

Includes "mu cond." Calibrate in the same manner as system conductivity. Refer to Section 5, page 22.

C) Main Menu/Set Points and Alarms

Includes "set point 2," high alarm 2," "low alarm 2" and "set point diff 2." The set point value is set in units of cycles. A cycle is the ratio of the system conductivity to the make-up conductivity.

D) Main Menu/Configure

Includes "mu cond" in the "input scale" menu.

OPERATION

The "set point 1" value sets the system conductivity set point in $\mu\text{S/cm}$. "Set point 2" is a second set point based on cycles of concentration (i.e., system conductivity/make-up conductivity). Blow down is activated based on the lowest of the two set points.

EXAMPLE: A plant has 2 water sources: one reads $100 \mu\text{S/cm}$, the second reads $200 \mu\text{S/cm}$. The system conductivity set point is set at $600 \mu\text{S/cm}$. The make-up set point (set point 2) is set at 5 cycles of concentration. If the source 1 ($100 \mu\text{S/cm}$) is used, the system would maintain a $500 \mu\text{S/cm}$ set point ($100 \mu\text{S/cm} \times 5 \text{ cycles} = 500 \mu\text{S/cm}$). If source 2 is the make-up water, the system would maintain a $600 \mu\text{S/cm}$ set point ($200 \mu\text{S/cm} \times 5 \text{ cycles} = 1000 \mu\text{S/cm}$).

14. BIOCIDES PROGRAMMING WORK SHEET

(Please make copies of this sheet for future use)

CHEMICAL NAME _____ BIOCIDES

PROGRAM #1

Week _____ Day _____

Start Time: _____:_____H:M

PROGRAM #2

Week _____ Day _____

Start Time: _____:_____H:M

PROGRAM #3

Week _____ Day _____

Start Time: _____:_____H:M

PROGRAM #4

Week _____ Day _____

Start Time: _____:_____H:M

Biocides ___ Run Time _____:_____H:M

Biocides ___ Pre-Bleed Time _____:_____H:M

Biocides ___ Pre-Bleed Min Conductivity _____:_____H:M

Biocides ___ Bleed Lock-Out _____:_____H:M

Make Copies and Repeat For Each Biocides

15. CONDUIT WIRING TABLE

Conduit units are factory predrilled with easily accessible terminals for hard wiring. See Relay Board, Diagram 4, 4a, pg. 30, 31, and Electrical Wiring section in this manual, pg. 7.

NOTE: Use only 16 (1.2 mm) or 18 AWG (1.5 mm) wire for conduit power and load connections. Never run power and signal wiring together in same conduits. (Example: Sensor Outputs with Power wiring)

relay/fuse	Relay 1		Relay 2	Relay 3	Relay 4	Relay 8
	B	C	D	E	F	I
Conductivity Controller with option						
Standard	INHIBITOR	BLOWDOWN				ALARM RELAY
C		BLOWDOWN	TIMER OUT 1			ALARM RELAY
CC		BLOWDOWN	TIMER OUT 1	TIMER OUT 2		ALARM RELAY
CE		BLOWDOWN	TIMER OUT 1	BIO A		ALARM RELAY
CCE		BLOWDOWN	TIMER OUT 1	TIMER OUT 2	BIO A	ALARM RELAY
CF		BLOWDOWN	TIMER OUT 1	BIO A	BIO B	ALARM RELAY
E	INHIBITOR	BLOWDOWN	BIO A			ALARM RELAY
F	INHIBITOR	BLOWDOWN	BIO A	BIO B		ALARM RELAY
G	INHIBITOR	BLOWDOWN	BIO A	BIO B	BIO C	ALARM RELAY
pH Controller with Option						
Standard		pH CONTROL				ALARM RELAY
C		pH CONTROL	TIMER OUT 1			ALARM RELAY
CC		pH CONTROL	TIMER OUT 1	TIMER OUT 2		ALARM RELAY
CE		pH CONTROL	TIMER OUT 1	BIO A		ALARM RELAY
CCE		pH CONTROL	TIMER OUT 1	TIMER OUT 2	BIO A	ALARM RELAY
CF		pH CONTROL	TIMER OUT 1	BIO A	BIO B	ALARM RELAY
E		pH CONTROL	BIO A			ALARM RELAY
F		pH CONTROL	BIO A	BIO B		ALARM RELAY
G		pH CONTROL	BIO A	BIO B	BIO C	ALARM RELAY
I		pH CONTROL	ORP CONTROL			ALARM RELAY
CI		pH CONTROL	ORP CONTROL	TIMER OUT 1		ALARM RELAY
CCI		pH CONTROL	ORP CONTROL	TIMER OUT 1	TIMER OUT 2	ALARM RELAY
CEI		pH CONTROL	ORP CONTROL	TIMER OUT 1	BIO A	ALARM RELAY
EI		pH CONTROL	ORP CONTROL	BIO A		ALARM RELAY
FI		pH CONTROL	ORP CONTROL	BIO A	BIO B	ALARM RELAY
Conductivity/pH Controller with option						
Standard		BLOW DOWN	pH CONTROL	TIMER OUT 1		ALARM RELAY
C		BLOW DOWN	pH CONTROL	TIMER OUT 1	TIMER OUT 2	ALARM RELAY
E		BLOW DOWN	pH CONTROL	TIMER OUT 1	BIO A	ALARM RELAY

INSTRUCTIONS: Find the type of your controller and its options in the far left column. Options that do not require wiring will not appear in the model number. Find the output in the columns to the right. The connection for that output will be the letter in the row labeled “Relay/Fuse Connection.”



Standard Products Operations
 27101 Airport Rd.
 Punta Gorda, FL 33982
 941-575-3800 Fax: 941-575-4085
 800-333-6677
 Fax Orders 800-274-6677