

# ***MicroVision* Timer**

---

MICROPROCESSOR TIMER CONTROLLER

## Installation Operation Manual



# Table of Contents

1.	INTRODUCTION .....	4
2.	MICROVISION FEATURES.....	4
2.1	Output Relays.....	4
2.2	Inputs: .....	4
2.3	Drum Levels.....	5
2.4	Flow Switch .....	5
2.5	Water Meter .....	5
2.6	Alarm Relay (Relay #5).....	5
3.	INSTALLATION .....	6
3.1	Opening The Enclosure.....	6
3.2	Location .....	6
3.3	Mounting Hardware .....	7
3.4	Flow Sensor Switch .....	7
3.5	TYPICAL INSTALLATION.....	8
4.	IMPORTANT SYMBOL INFORMATION.....	8
5.	ELECTRICAL WIRING .....	9
5.1	RELAY BOARD CONNECTIONS .....	10
5.2	Conduit Models (Wiring High Voltage).....	10
5.3	LOW VOLTAGE CONNECTIONS .....	11
5.4	Inputs.....	12
5.4.1	Input # 1 .....	12
5.4.2	Input # 2 to # 4.....	12
5.4.3	Input # 5 .....	12
5.5	Alarm Relay .....	12
6.	FRONT PANEL DESCRIPTION.....	13
6.1	Keypad Operation .....	13
7.	CONTROLLER PROGRAMMING .....	14
7.1	Menu Tree.....	14
7.2	Menu Navigation .....	14
7.3	Home screen.....	15
7.4	Main Menu.....	15
7.5	Status Screen.....	15
7.6	Configure Menu .....	16
7.7	Date/Time Menu .....	17
7.8	HOA Outputs Menu .....	17
7.9	Inputs Menu .....	18
7.10	Drum Levels Sub Menu .....	18
7.11	Display Contrast Setting .....	19
7.12	Gallons or Liters .....	19
7.13	Scrolling.....	19
7.14	Totalizers.....	19
7.15	Password Setting.....	20
8.	Troubleshoot Screen .....	20
9.	Software Version .....	21
10.	Factory Reset Function .....	21
11.	Settings Menu .....	21
11.1	Timer Mode Menus.....	22
11.2	Timer Modes – Pulse Timer Menu .....	22
11.3	28 Day Menu.....	23
11.4	28 Day Menu – Days/Weeks Menu .....	23
11.5	Cycle Timer Menu .....	24

11.6	Cycle Timer Menu – Start Times.....	24
12.	Factory Defaults.....	25
13.	TROUBLESHOOTING GUIDE .....	26
14.	MAINTENANCE .....	27
15.	SPECIFICATIONS .....	27
16.	MOUNTING HOLE PATTERN (Footprint).....	28
17.	Factory Service Policy .....	29
18.	Warranty .....	29

# 1. INTRODUCTION

The *MicroVision* microprocessor based cooling tower controller has been designed to control up to four (4) independent powered timer outputs. Each output can be programmed in any one of the following modes, Pulse timer, Percent timer, 28 day Biocide timer, or as a cycle timer. Relay number 5 may be programmed as an alarm dry contact or as a fifth timer with a dry contact output.

The *MicroVision* has five (5) output relays assigned as follows:

Relay 1 – Timer #1

Relay 2 – Timer #2

Relay 3 – Timer #3

Relay 4 – Timer #4

Relay 5 – Alarm or Timer #5 (normally open dry contact)

## 2. MICROVISION FEATURES

### 2.1 Output Relays

The control of the four HANDS – OFF – AUTO (HOA) output relays can be controlled using the HOA menu.

RELAY STATUS	LED COLOR
ON (FORCED ON FOR 5 MIN.)	AMBER
OFF	RED
AUTOMATIC 'ON'	GREEN
AUTOMATIC 'OFF'	OFF

### 2.2 Inputs:

The *MicroVision* has 5 digital inputs that can be programmed as follows:

Programmable Inputs	Input 1	Input 2	Input 3	Input 4	Input 5
Drum Level	X ( Timer 1)	X (Timer 2)	X (Timer 3)	X (Timer 4)	X (Timer5)
Water meter	X	X	X	X	X
Hall effect	X				
Flow					X

## 2.3 Drum Levels

When an input is defined as a drum level it is linked to the corresponding relay output. For example, if input #1 is set as drum level, it will be linked to relay one and may be set by the user to either deactivate the relay, or only to activate an alarm.

## 2.4 Flow Switch

*MicroVision* has a dry contact flow switch option for input number 5 only that will deactivate all of the control output relays upon a no-flow indication. An Alarm condition will be indicated and “No Flow” will be displayed. This input is active closed:  
Open = no flow; closed = flow.



If a flow switch input or other alarm condition exists, the four (4) LED's will flash until the alarm condition is cleared.

## 2.5 Water Meter

Each input may be programmed as water meter inputs that are capable of reading a dry contact water meter. Input number one can be set to read a hall effect type water meter. Through programming this input can be used to feed inhibitor as well as totalizing water consumption.

## 2.6 Alarm Relay (Relay #5)

*MicroVision* has a dedicated dry contact relay that can be used to interface with process control equipment or visual indicators. This relay is un-powered and may also be programmed as a timer.

# 3. INSTALLATION

## 3.1 Opening The Enclosure<sup>1</sup>

Loosen the four (4) screws on the front of the controller and carefully swing the top of the case to the right (Fig. 1).

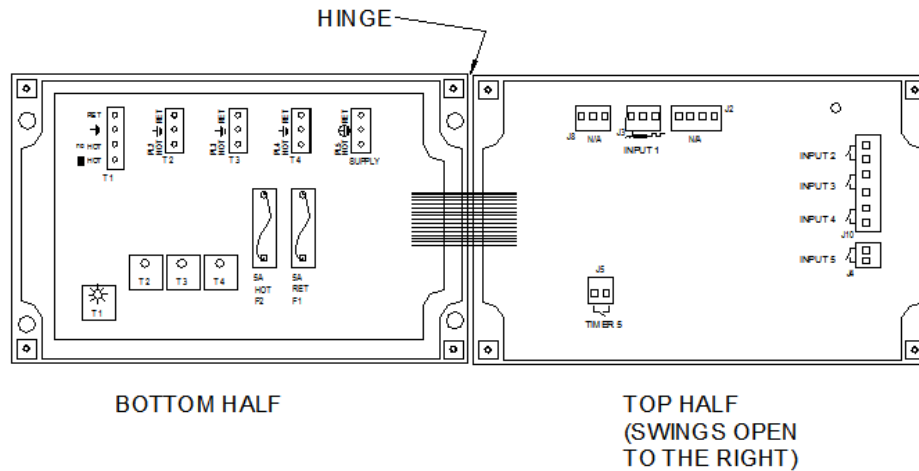

Fig. 1

## 3.2 Location

Select a mounting location convenient to grounded electrical and plumbing connections. It is recommended that you mount the controller on a wall or other vertical surface with adequate lighting at a comfortable level. Installation should comply with all national, state, and local codes.



**AVOID LOCATIONS WHERE THE CONTROLLER WOULD BE SUBJECTED TO EXTREME COLD OR HEAT {LESS THAN 0°F (-17,8°C) OR GREATER THAN 122°F (50°C)}, DIRECT SUNLIGHT, VIBRATION, VAPORS, LIQUID SPILLS, OR EMI (ELECTROMAGNET INTERFERENCE; E.G., STRONG RADIO TRANSMISSION AND ELECTRIC MOTORS.)**



**SAFETY PROTECTION PROVIDED BY THE EQUIPMENT MAY BE IMPARED IF THE EQUIPMENT IS USED IN A MANNER NOT SPECIFIED BY THE MANUFACTURER. THIS CONTROLLER IS INTENDED FOR INDOOR USE ONLY.**

<sup>1</sup> Trained service personnel are required for all electrical connections. This product does not contain operator serviceable parts.

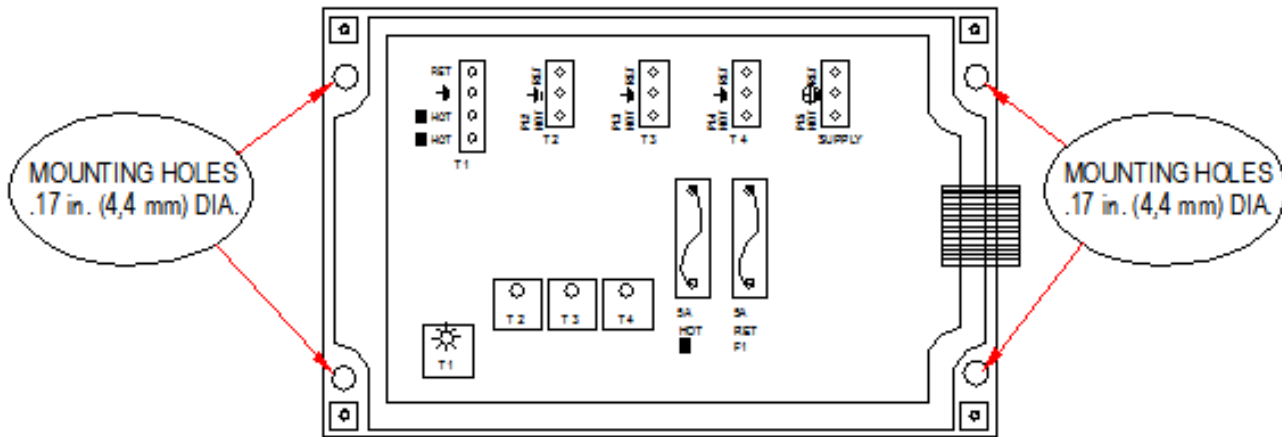

Fig. 2

Mount the bottom half of the controller using the four (4) holes provided (Fig. 2).

### 3.3 Mounting Hardware

For panel mounts without threaded inserts, four number 8 self tapping screws are the minimum recommendation.

For panel mounts with threaded inserts, four 8-32 screws are the minimum recommendation.

Panel mount hardware should support 25lbs. For hole locations, see the mounting hole pattern (Fig. 9) found on the page 22 of manual.

### 3.4 Flow Sensor Switch

If your controller is provided with a flow switch, install the flow switch so that flow enters into the bottom of the flow switch tee, and out of the side of the tee. The flow switch must always be installed in a vertical position so that the sensor wire is coming out of the top, and the internal (red) flow shuttle is able to rise when there is flow and drop when there is no flow. The flow switch is activated when 1 GPM (3,8 LPM) is going through it, and is deactivated when the flow drops below 1 GPM (3,8 LPM).

### 3.5 TYPICAL INSTALLATION

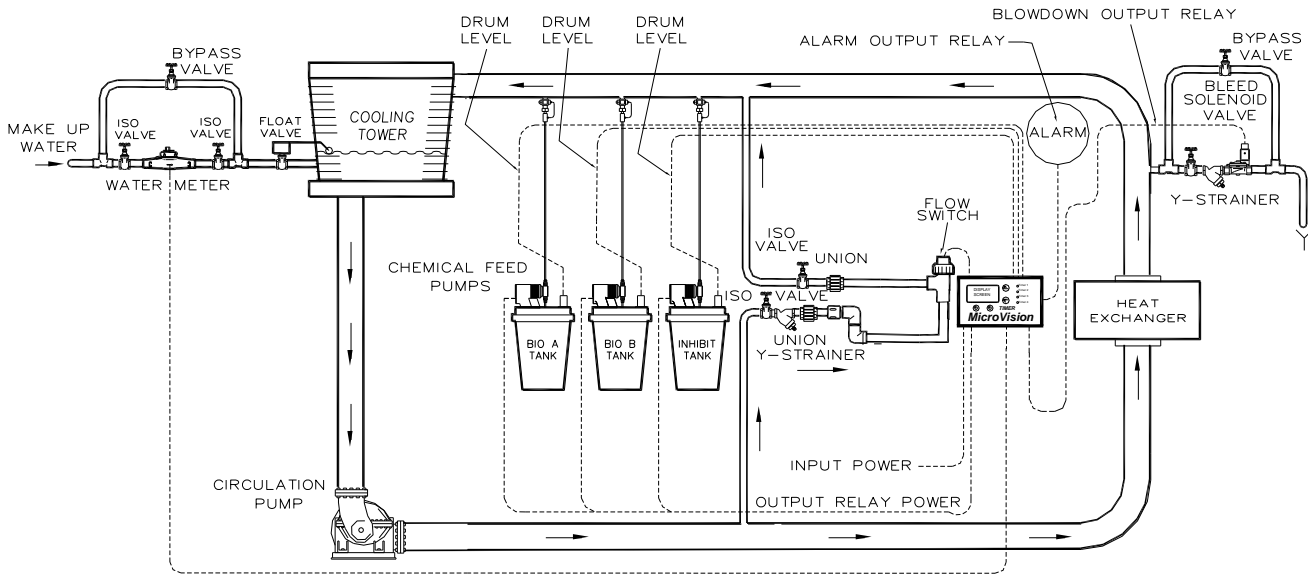

Fig. 3

### 4. IMPORTANT SYMBOL INFORMATION



Warning indicates a condition that could cause damage to both the equipment and the personnel operating it. Pay close attention to any warning.



Primary Supply Ground must be connected to earth ground for safe operation of your controller.



Chassis Ground – Connect your equipment's ground wire here for safe operation of your external devices.



## 5. ELECTRICAL WIRING<sup>2</sup>



**Controller must be wired in accordance with all applicable electrical codes.**



**Input power must be 120 or 220VAC Single Phase.**



**Trained service personnel are required for all electrical connections. This product does not contain operator serviceable parts.**



**Devices attached to any Relay connection must be Single Phase and rated for the same voltage as the input voltage to the product. (e. g. 120VAC MicroTrac controllers support 120VAC relay attached devices exclusively and 220VAC MicroTrac controller support 220VAC relay attached devices exclusively.)**



**Input power cord must be disconnected from power source prior to opening the product's enclosure and making any electrical connections.**



**The controller should be connected to a dedicated power branch (i.e., its own wiring, circuit breaker, etc.). For best results, the ground should be independent (true earth) not shared.**



**A switch or circuit-breaker, marked as the unit's disconnecting device should be included in the installation. It should be in close proximity to the unit and easily reached by the user.**

The MicroVision electronic input circuitry is fuse protected on both the hot and neutral inputs using a replaceable five (5) amp fuse (Fig .6). For additional protection of your instrument, use of a surge protector is recommended.

Pre-wired controllers are supplied with a 3-wire grounded power cord and 3-wire grounded receptacle cords for all controlled line voltage outputs.

---

<sup>2</sup> Trained service personnel are required for all electrical connections. This product does not contain operator serviceable parts.

## 5.1 RELAY BOARD CONNECTIONS<sup>3</sup>

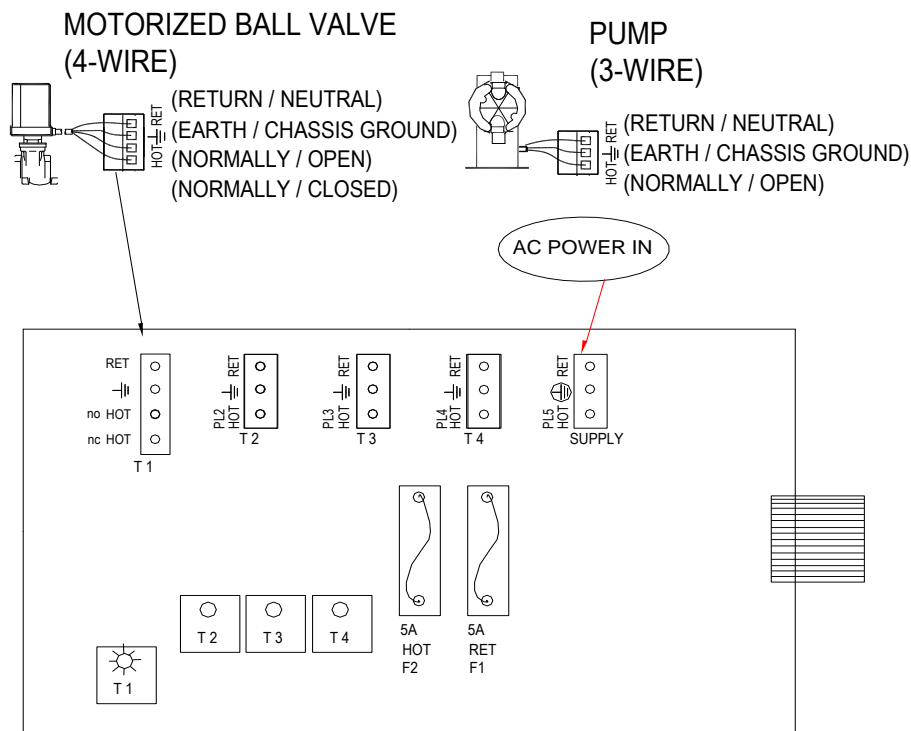

Fig. 4

## 5.2 Conduit Models (Wiring High Voltage)<sup>4</sup>

Conduit controllers have openings for conduit connections for hard wiring. (See Fig. 4) for input and output power connections. Use only 18 AWG (1,2 mm<sup>2</sup>) stranded wire for conduit power and load connections. Supply (input) power is connected via **PL5** located on the relay board (Fig. 4). The top part of this terminal block is removable to allow for easy access to the connector's three (3) screws.



WARNING

**Devices attached to any Relay connection must be Single Phase and rated for the same voltage as the input voltage to the product. (e. g. 120VAC MicroTrac controllers support 120VAC relay attached devices exclusively and 220VAC MicroTrac controller support 220VAC relay attached devices exclusively.) Do not apply power until this condition is verified.**



NOTE

**Make sure that all conduit connections are water tight.**

<sup>3</sup> Trained service personnel are required for all electrical connections. This product does not contain operator serviceable parts.

<sup>4</sup> Trained service personnel are required for all electrical connections. This product does not contain operator serviceable parts.

The four (4) powered output relay terminal blocks are identified as: **PL1 (Timer 1)**, **PL2 (Timer 2)**, **PL3 (Timer 3)**, and **PL4 (Timer 4)**. These terminal blocks can be removed in the same manner as **PL5**. The Timer 1 relay has a N.O. and a N.C. connection, the others are only N.O. **J5** is the alarm dry contact (or timer 5) output relay.

### 5.3 LOW VOLTAGE CONNECTIONS<sup>5</sup>

The low voltage connections are found on the low voltage (right side) board (Fig. 5). Use 22-24 AWG (.76 mm<sup>2</sup>) wire for: flow switch, drum levels, dry alarm, and water meter connections. These signal wires must be run separate from AC power lines.

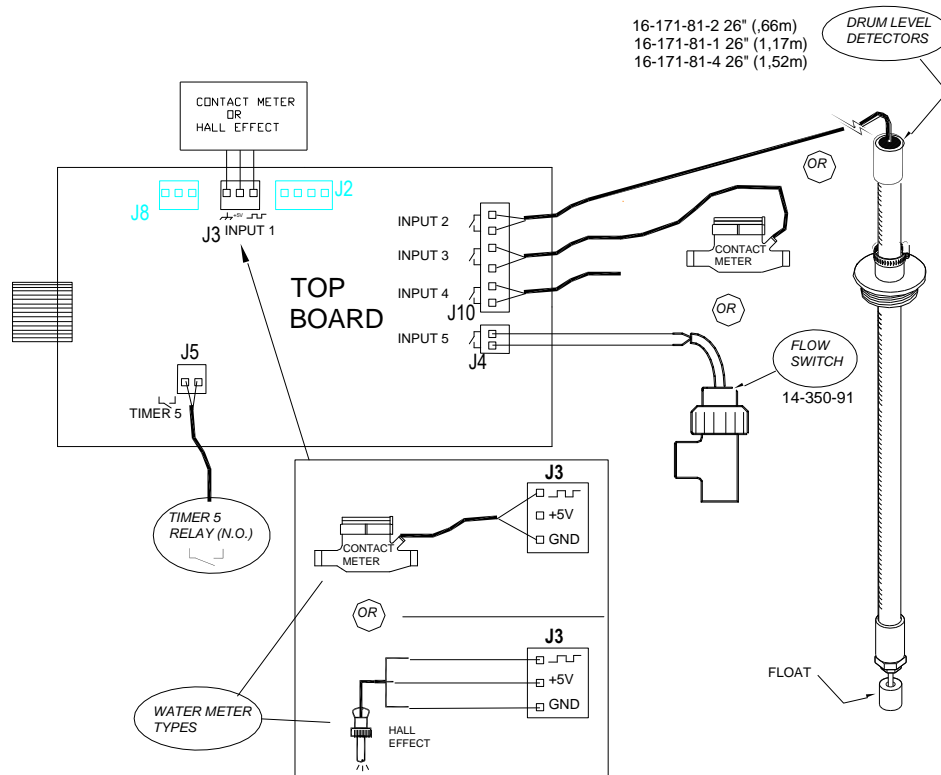

Fig. 5



A Hall effect water meter can only be attached to J3 (Input #1).



Low voltage signal wires, e.g., a water meter, must be run separate from AC power lines. These connections will be covered in the **Low Voltage** section of the manual.

<sup>5</sup> Trained service personnel are required for all electrical connections. This product does not contain operator serviceable parts.

## 5.4 Inputs

### 5.4.1 Input # 1

Connect your water meter, or drum level switch to **J3** of the top board. For proper connections, refer to (Fig. 5) for your meter type, Hall effect, or contacting head may be used.

### 5.4.2 Input # 2 to # 4

Connect your water meter, or drum level switch to **J10** (Fig. 5). They are labeled as, **Input 2, 3, and 4**. These are active closed: closed = low level; open = level is OK.

### 5.4.3 Input # 5

Connect your water meter, drum level switch, flow switch, or auxiliary dry contact wires to **J4**



If you do not have a flow switch, a jumper wire must be connected across J4 if input number 5 is programmed as flow.

## 5.5 Alarm Relay

Use J5 to connect your alarm reporting equipment. This relay will close when an alarm condition exists and will open when no alarm conditions are present. See the Trouble Shooting Guide (Page 21) for a description of alarm codes and their probable causes.

## 6. FRONT PANEL DESCRIPTION

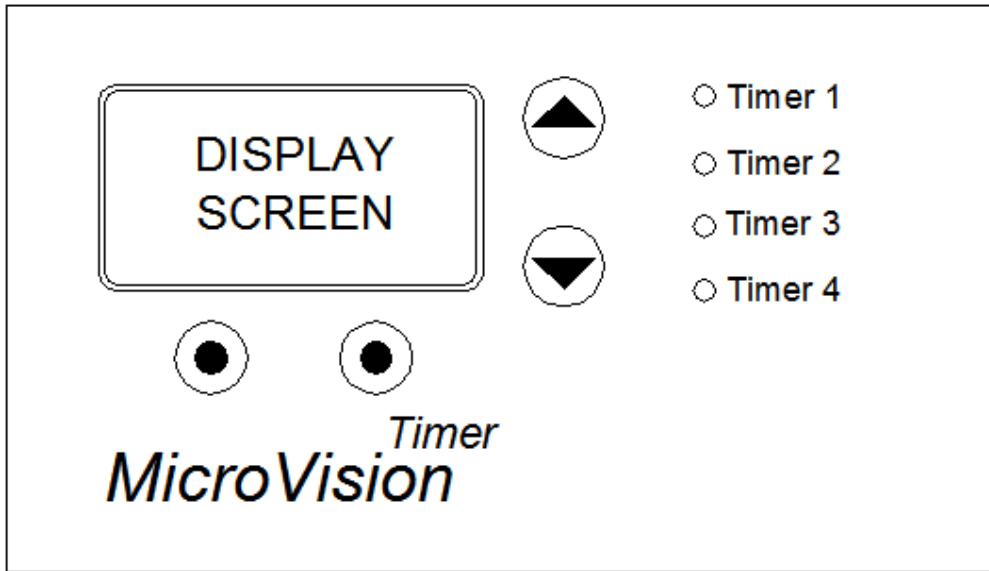

Fig. 6

### 6.1 Keypad Operation

**UP/DOWN** - Dual function keys. Used to move the select (highlighted) box and to increase and decrease values.

- ● - Soft keys used for various functions depending on currently displayed screen. The key's function appears above the key on the display.

# 7. CONTROLLER PROGRAMMING

## 7.1 Menu Tree

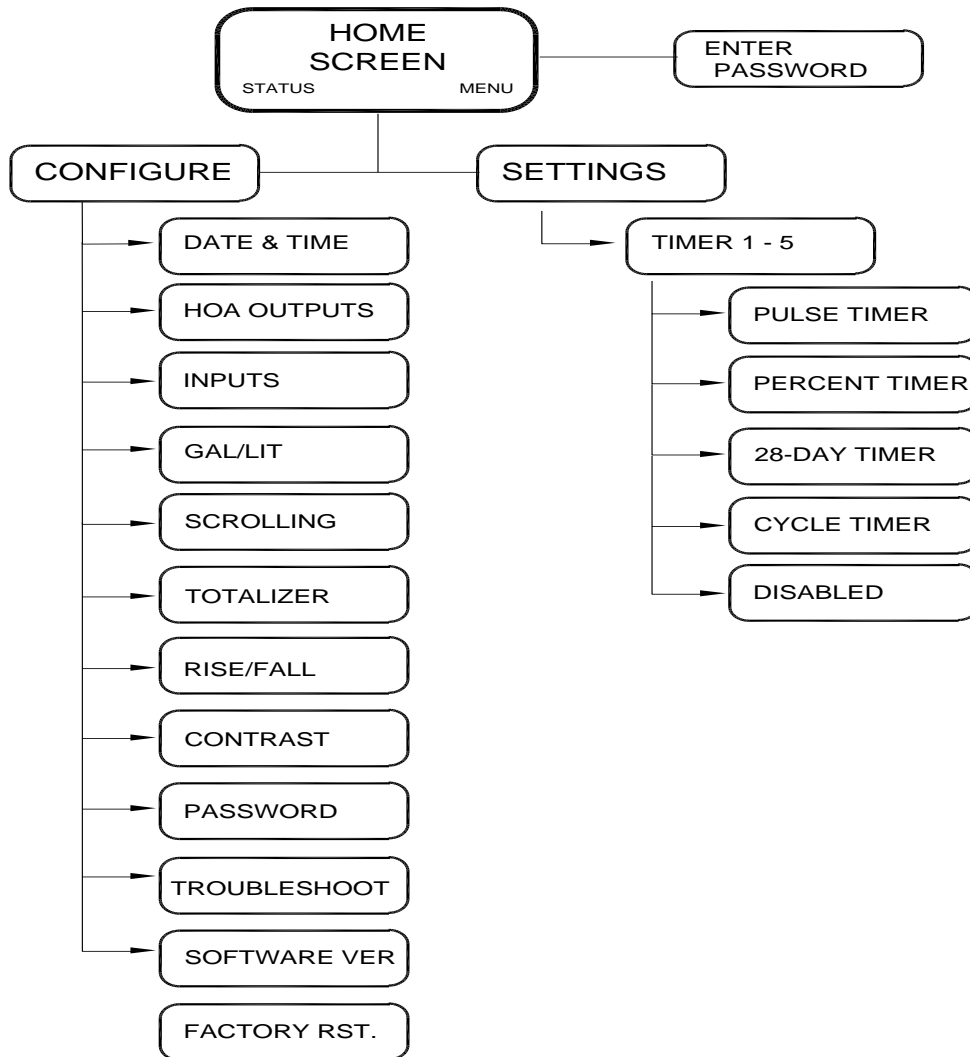

## 7.2 Menu Navigation

MicroVision uses four front panel buttons to navigate through the different menus. Use these buttons to move up and down within a list of options or move right and left to enter or change parameter values. In some cases the Microvision display will prompt you to press the different buttons to assist you in selecting or changing data.

Some menus may display highlighted menu options or a checkmark (✓) next to a menu option. The highlighted menu option is used to indicate that another menu will be displayed if this option is chosen. The checkmark indicates that a particular control mode has been selected.

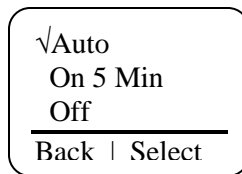
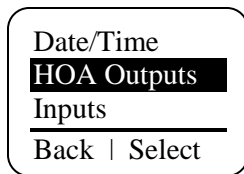

### 7.3 Home screen

This screen is displayed during normal operation when there are no alarm conditions on the Microvision. If an alarm condition occurs an alarm message will flash on the screen. The four LED's to the right of the display will also flash indicating an alarm has occurred. The Microvision will return to this screen if no buttons are pressed for five minutes after entering a menu.

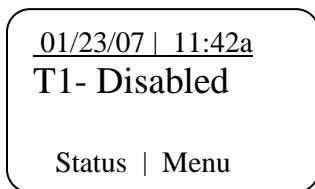

### 7.4 Main Menu

The Main menu is the starting point for all subsequent menus.

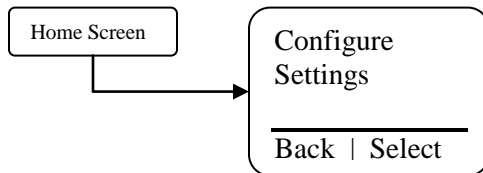

**Configure** – This menu allows you to set the time and date, display contrast, water meter, etc.

**Settings** – This menu allows you to set the timer feed modes.

### 7.5 Status Screen

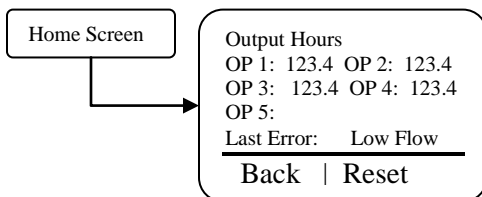

This screen shows the real-time data relating to the controller. This screen can be used to log the amount of time a particular output was energized since it was last reset.

Below is a description of each of the data fields:

**OP 1** – The amount of time, in hours, the Timer 1 output was energized since it was last reset.

**OP 2** – The amount of time, in hours, the Timer 2 output was energized since it was last reset.

- OP 3** – The amount of time, in hours, the Timer 3 output was energized since it was last reset.
- OP 4** – The amount of time, in hours, the Timer 4 output was energized since it was last reset.
- OP 5** – The amount of time, in hours, that the dry contact relay 5 was energized since it was last reset.
- Last Error** – Shows the most recent error that was displayed on the controller. Pressing the reset key will cause the hour timers and water meter to reset to zero.

## 7.6 Configure Menu

From the Configure menu you can select many different system configuration options.

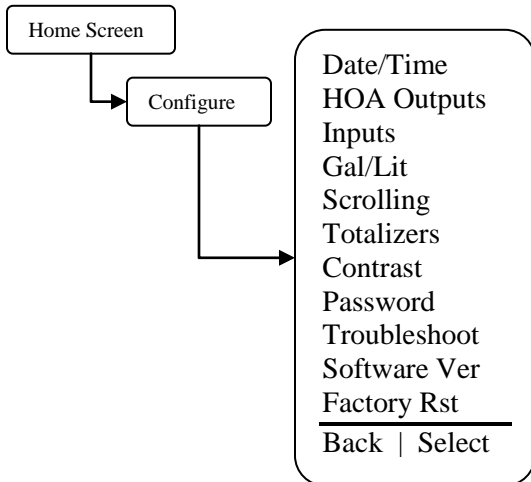

- Date/Time** – Set the current date, date format, time, and time format.
- HOA Outputs** – Manually control the five relays.
- Inputs** – Set the input type, drum level, or water meter type and volume.
- Gal/Lit** – Set the display in Gallons or liters.
- Scrolling** – Set the time between each timer’s status scrolling speed on the home screen.
- Totalizers**- View the water meter totalizer values since the last user reset.
- Contrast** – Set the display contrast.
- Password** – Set the user password.
- Troubleshoot** – View the signal inputs in real-time to diagnose wiring problems.
- Software Version** – Displays the current software version.
- Factory Restore** – Restore the parameters to factory default.



## 7.7 Date/Time Menu

From the Date/Time menu you can set the date and time as well as the date and time display formats.

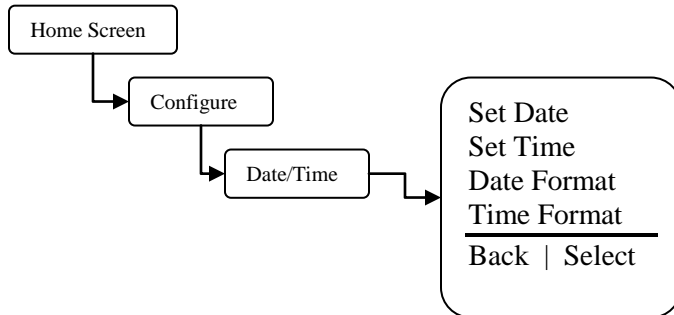

**Set Date** – Set the current date.

**Set Time** – Set the current time.

**Date Format** – Pick the day/month/year format.

**Time Format** – Pick the 12-hour or 24-hour time of day format.

## 7.8 HOA Outputs Menu

From the HOA Outputs menu you can manually set the four relay control outputs. This is useful for servicing chemical pumps or troubleshooting electrical problems. You must first select the relay output to be controlled then select the relay state.

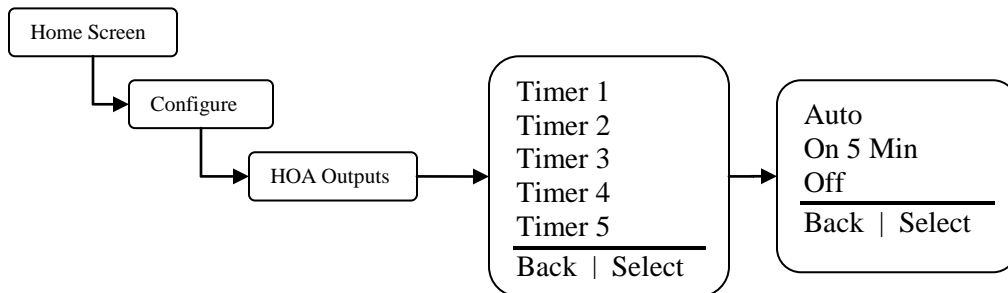

**Auto** – Return the control output to normal operation.

**On 5 Min** – Energize the control output for five minutes.

**Off** – De-energize the control output indefinitely.



**NOTE**

Forcing the output to Auto may cause the control output to energize without warning.

## 7.9 Inputs Menu

From the Inputs menu you select what type of device the controller is attached to. Once the type of input has been entered the next screen will ask you for the gallons/liters per pulse or “K-factor”, or level action depending on the type of device.

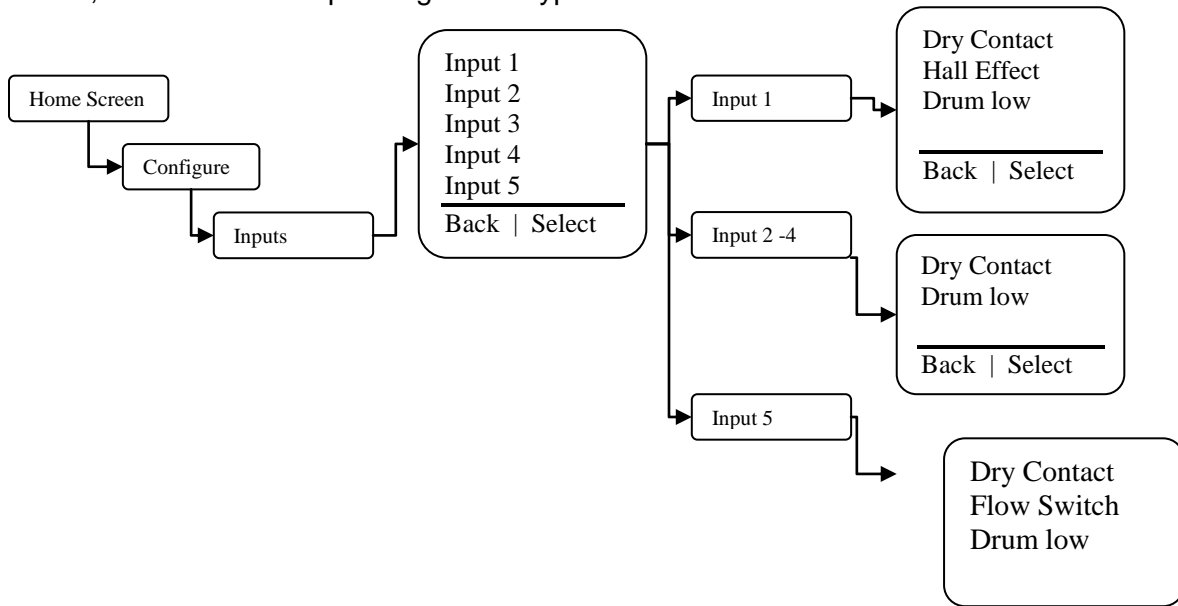

**Input Type** – Select between a dry contact or Hall-effect water meter, or drum level on input 1. Select between a dry contact water meter, or drum levels on input 2 to 4. Select between a dry contact water meter, or drum level or flow switch on input 5. Once the type is selected as a water meter the resolution or volume per pulse is then set.

## 7.10 Drum Levels Sub Menu

From the Drum Level menu you select how you want the chemical pump control output to respond to a low drum level indication. Your choices are to allow the pump to continue to run or have the pump stop when its drum level goes low. Input one is tied to relay one

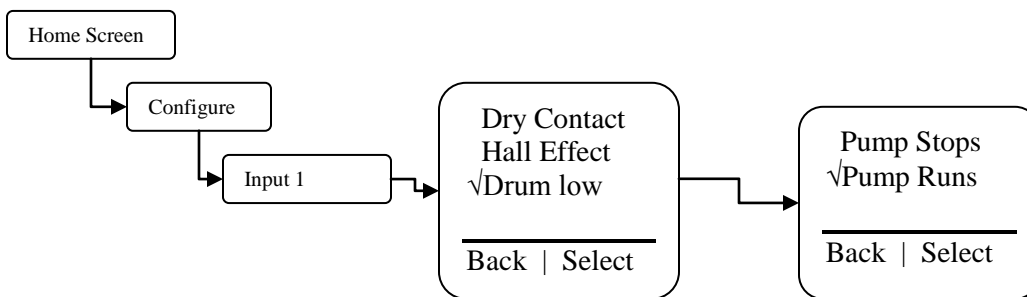

**Pump Stops** – Selecting this mode causes the timer outputs to de-energize when their drum level goes low.

**Pump Runs** – Selecting this mode causes the timer outputs to remain energized even though their drum level has gone low.



When a drum level goes low the controller will go into alarm regardless of this setting. Re-filling a low drum may cause the pump control output to energize without warning.

## 7.11 Display Contrast Setting

From the Display Contrast setting you adjust the display contrast to give the best clarity and readability of the display screen.

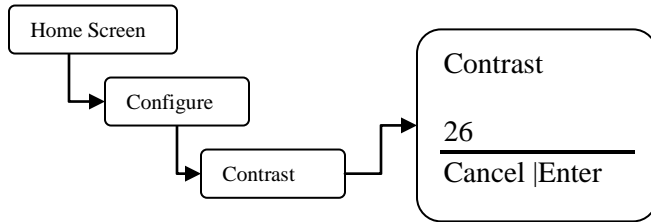

**Contrast** – Adjust this value up or down to give you the best display contrast.

## 7.12 Gallons or Liters

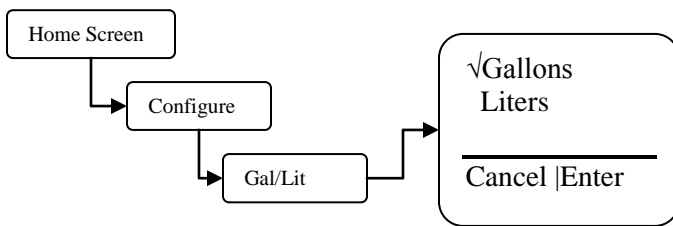

**Gal/lit** – Set how the controller should display the water meter units of measure.

## 7.13 Scrolling

From the Display Scrolling setting you can adjust how frequently the controllers display will scroll from one timer's status to the next timer on the home screen.

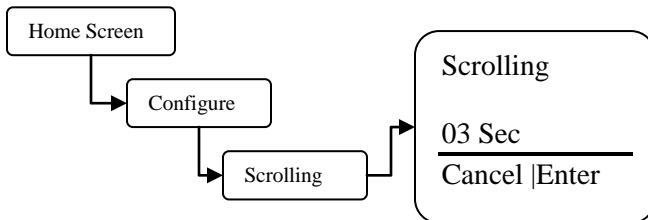

**Scrolling** – Set the number of seconds to scroll.

## 7.14 Totalizers

From the Totalizers screen you can view the totalized values of each of the five possible water meter inputs and reset them if desired.

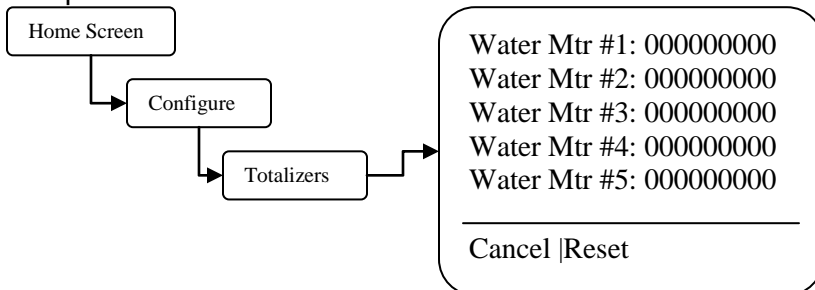

**Reset** – Sets the totalizers back to zero.

## 7.15 Password Setting

From the Password setting you select the user password that will be required to gain access to the Configuration and Settings menus. Once the password is set to anything other than 0000 (4-zeros) the password feature is enabled. To disable password protection return the password to 0000 (4-zeros).

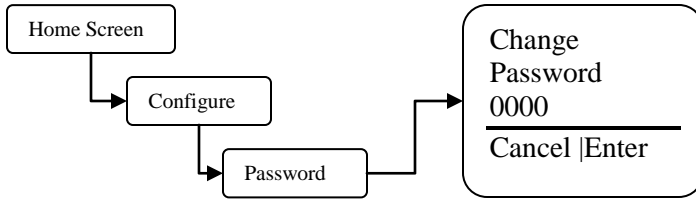

**Password** – Set the user password.



Once the password is set the controller will require a password to access any menus. If the password is lost or unknown you will have to call technical service to gain access to the controller menus. Please have the controller in front of you when you place the call.

## 8. Troubleshoot Screen

From the Troubleshoot Screen you can view the Microvision control inputs in real-time. This is a great tool for checking the correct operation of sensors that are attached to the controller.

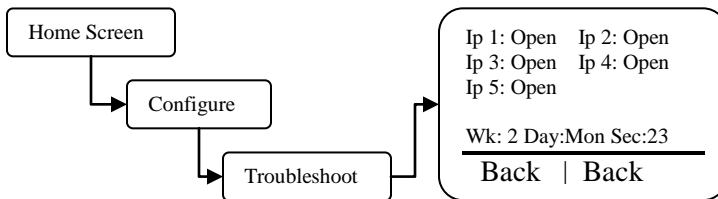

**Flow input** – Water flow switch input (J4 pins 1-2). Flow=closed, No flow = open.

**Drum Levels** – Inhibitor drum level input Empty=closed, OK=open.

**Water Meter** – Water meter input (J3 pins 1-3). Open=contact open, closed=contact closed.

**Wk** – Revolving week number between one and four. This is used in the biocide Days/Weeks settings.

**Day** – Day of week. This is used in the biocide Days/Weeks settings.

**Sec** - Current clock seconds.



While this screen is displaying information the controller is still functioning normally and relay outputs may energize without warning due to changing signal inputs.

## 9. Software Version

From the Software Version screen you can view the current software that is running in the Microvision controller.

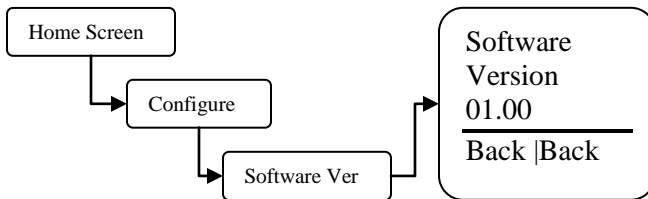

## 10. Factory Reset Function

From the Factory Reset Function screen you can force the controller to reset all of its internal parameter to the factory default values.

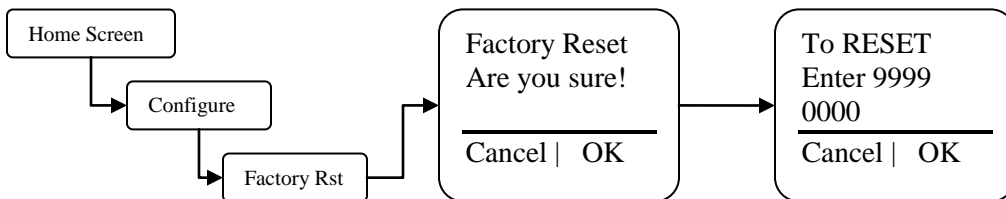

Use this function to reset the controller back to the factory defaults.



**NOTE** Be absolutely certain you want to reset all the parameters back to the factory defaults. Once the reset takes place there is no way to retrieve the previous parameters.

## 11. Settings Menu

From the Settings menu you access the timer mode and parameter sections.

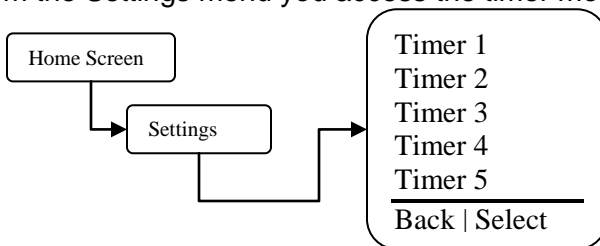

## 11.1 Timer Mode Menus

From this menu pick the mode that the inhibitor feed will follow.

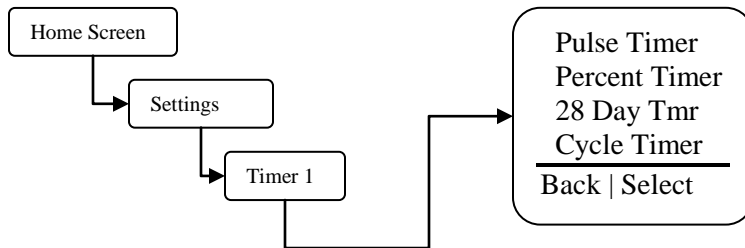

**Pulse Timer** – See the menu for this function in the following section.

**Percent Timer** – Set the timer run time period and percentage of the time period.

Example: Cycle Time=60minutes, % Minutes to run=10, the timer will run for 10% of 60 minutes, or 6 minutes every 60 minutes.

**28 Day Timer (Biocide)** – See the menu for this function in the following section.

**Cycle Timer** - See the menu for this function in the following section.

## 11.2 Timer Modes – Pulse Timer Menu

From this menu configure how you want the inhibitor to feed while in pulse timer mode. This mode uses the water meter input to cause a counter to accumulate a certain volume of water before the inhibitor is feed. Once the accumulated volume is reached the inhibitor is feed for the programmed Feed Time.

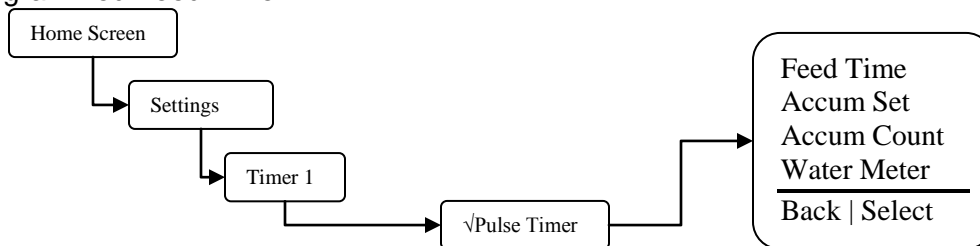

**Feed Time** – Set this value to the amount of time you want the timer to run for when the water meter accumulator reaches its target.

**Accumulator Set** – Set this value to the amount of water that needs to accumulate prior to a timer run time. The units will be in gallons or liters depending on what you set the water meter units to.

**Accumulator Count** – This is the current running count of the water meter accumulator.

**Water meter** – Select which of the five possible water meter inputs will activate the pulse timer.

## 11.3 28 Day Menu

From this menu configure how often and the duration you want the timer to run.

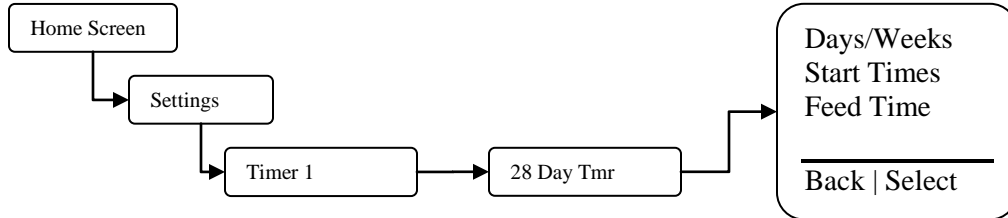

**Days/Weeks** – Set the days and weeks you want the timer to run for. See the next section for details on how to set the days and weeks.

**Start Times** – Set up to four start times. Setting the value to 00:00 means the start time is ignored.

**Feed Time** – Set this value to the amount of time you want the timer to run for each time a cycle is started.

## 11.4 28 Day Menu – Days/Weeks Menu

From this menu configure the days and weeks the timer will activate. Any combination of days and/or weeks is acceptable for each timer.

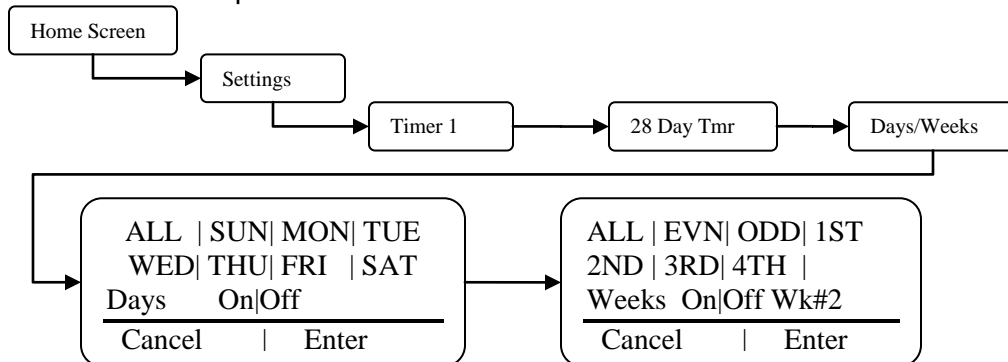

- Select the timer start days and weeks by using the up and down buttons to the right of the display. Move the cursor to the right or left by using the button to the bottom of the display. The selected day or week will flash as the cursor is moved to each setting. The flashing On|Off text indicates if the current setting is on or off.

- If a day or week is highlighted, or appears as reverse video, that particular day or week will activate the timer.

- The week # shown in the lower right of the display indicates which week number the controller's time is currently set to.

## 11.5 Cycle Timer Menu

From this menu configure how often and the duration you want the timer to run for. The cycle timer is very similar to the 28 day timer

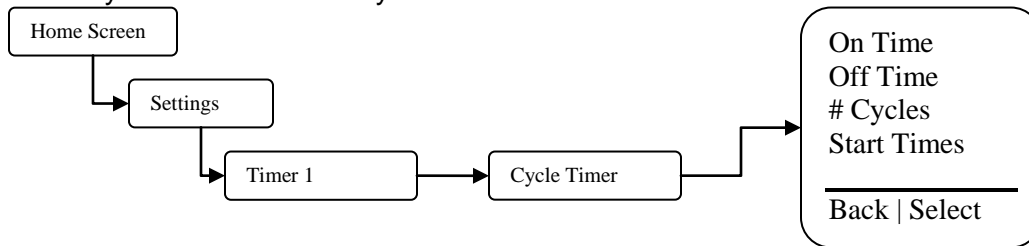

**On Time** – Sets the duration that the timer will activate the output for.

**Off Time** – Sets the duration that the timer will deactivate the output for.

**# Cycles** - Set the number of times the timer will repeat the on and off times at the start time setting described below.

**Start Times** – Set up to four start times. Setting the value to 00:00 means the start time is ignored. Set the days and weeks you want the timer to run for. See the next section for details on how to set the days and weeks.

## 11.6 Cycle Timer Menu – Start Times

From this menu configure the days and weeks the timer will run for. Any combination of days and/or weeks is acceptable for each timer.

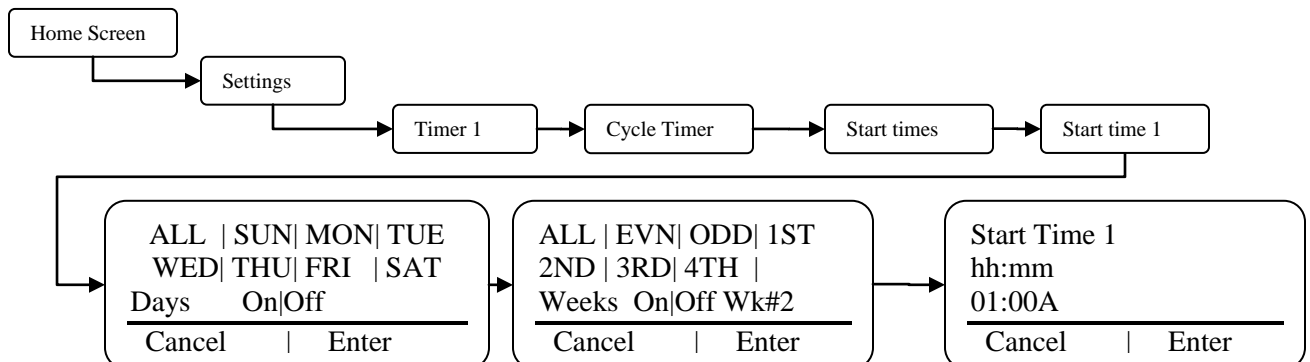

- Select the timer start days and weeks by using the up and down buttons to the right of the display. Move the cursor to the right or left by using the button to the bottom of the display. The selected day or week will flash as the cursor is moved to each setting. The flashing On|Off text indicates if the current setting is on or off.

- If a day or week is highlighted, or appears as reverse video, that particular day or week will have biocide feed.

- The week # shown in the lower right of the display indicates which week number the controller's time is currently set to.



## 12. Factory Defaults

Parameter	Default
<b>Configuration</b>	
• Date Format	MM/DD/YY
• Time Format	12hr Clock
• Inputs	Dry Contact
• Water Meter Pulse Volume	100
• Units	Gallons
• Drum Levels	Pumps Run
• Scrolling	3 Seconds
• Display Contrast	26
• Password	0000(disabled)
<b>Settings</b>	
• Timer Modes	Disabled

# 13. TROUBLESHOOTING GUIDE

Symptom	Probable Cause	Possible Solution
Controller does not power up.	No power supplied to controller.	Insure that correct voltage is supplied to controller.
		Check circuit breaker supplying power to the controller.
	Fuse is blown.	check/replace fuses F1-F3 ( <i>see Figure 2, Page 5</i> )
	Ribbon cable.	Check ribbon cable connecting upper and lower pc boards inside controller.
Controller displays "No Flow" alarm message.	No flow thru flow assembly.	Insure there is enough water flow through the assembly. At least 1 GPM (3.8 LPM) of flow.
	Flow switch wiring or connector loose.	Check flow switch connections ( <i>see Figure 5, Page 8</i> ).
	Flow switch stuck.	Clean flow switch sensor mechanicals.
	Flow assembly clogged.	Clean inside flow assembly.
	Flow switch input jumper missing.	Install jumper if flow switch is not used.
Controller displays "Drum X Low" alarm message.	Drum fluid level low.	Refill drum for timer X. (where x =1 to 5)
	Drum level switch wiring or connector loose.	Check switch connections ( <i>See Figure 5, Page 8</i> ).
	Drum level switch stuck.	Clean switch sensor mechanicals.
Controller displays "Clock Err" alarm message.	Internal controller clock failure.	Replace controller.
Controller displays "Watchdog" alarm message.	Internal controller failure.	Replace controller.

## 14. MAINTENANCE

There are no regular maintenance requirements. All other service should be performed by factory authorized personnel only. Modifications to or tampering with the circuit level components makes all warranties, written or implied, and/or manufacturer's responsibility for this controller, null and void.



**DISCONNECT POWER BEFORE OPENING THE UNIT TO ACCESS FUSES. MAKE SURE THAT REPLACEMENT FUSES ARE OF SAME TYPE TO MAINTAIN SAFETY APPROVALS.**

FUSE <sup>6</sup>	TYPE
F1 & F2	5A, IEC 60127-2 · 250 VAC · Time-Lag T
F3 <sup>7</sup>	1A, 2AG, Time Lag, 250VAC

## 15. SPECIFICATIONS

Controller	
Enclosure	NEMA 4X/ Designed to meet IP65
Enclosure Dimensions	6.4" x 3.2" x 3.2" (163 x 82 x 82mm)
Power supply	120 or 220 VAC; 50/60Hz.
Display	LCD 0 - 9,999 $\mu$ S/cm range 1 $\mu$ S/cm resolution
Maximum relay output current	120 VAC: <ul style="list-style-type: none"> <li>• 5 A Resistive/General use</li> <li>• 4LRA/4FLA, 1/10HP (motors)</li> </ul> 220 VAC: <ul style="list-style-type: none"> <li>• 5 A Resistive/General use</li> <li>• Not rated for motors</li> </ul>

Flow Switch	
Maximum temperature	127°F (52°C)
Maximum pressure	125 PSI (8,6 BAR)
Activate flow rate	Approximately 1 GPM (3,785 LPM)
Materials of construction	PVC and Glass filled Polypropylene

<sup>6</sup> All fuses are UL, CSA recognized or listed.

<sup>7</sup> F3 is not serviceable in the field.

# 16. MOUNTING HOLE PATTERN (Footprint)

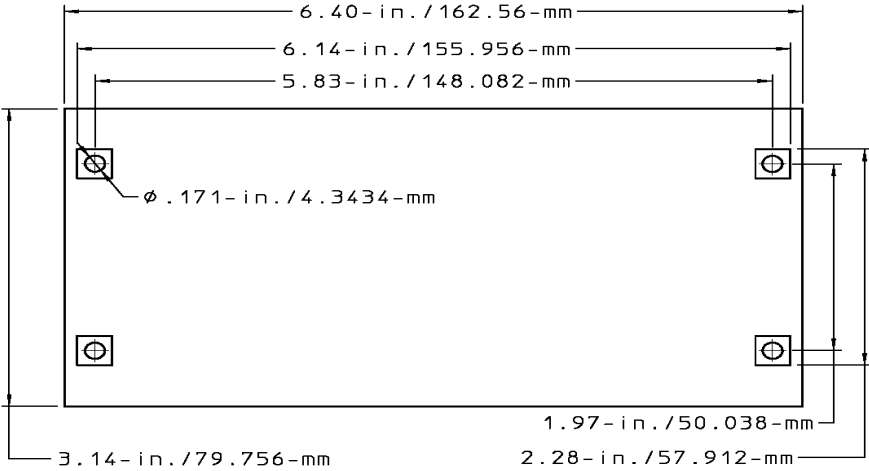

Fig. 7

## 17. Factory Service Policy

Your MICROVISION is a state of the art microprocessor based controller. If you are experiencing a problem with your process control instrument, first consult the troubleshooting guide in this manual. If the problem is not covered or cannot be solved, contact Technical Services for assistance:

PULSAFEEDER INC. (SPO)  
27101 AIRPORT ROAD  
PUNTA GORDA, FL 33982  
941-575-3800

Trained technicians are available to diagnose your problem and arrange a solution. Solutions may include purchase of replacement parts or returning the controller to the factory for inspection and repair. All returns require a Return Authorization number to be issued by Pulsafeeder. Parts purchased to correct a warranty issue may be credited after an examination of original parts by Pulsafeeder. Warranty parts returned as defective which test good will be sent back freight collect. No credit will be issued on any replacement electronic parts.

Any modifications or out-of-warranty repairs will be subject to bench fees and costs associated with replacement parts.

## 18. Warranty

Pulsafeeder, Inc. warrants control systems of its manufacture to be free of defects in material or workmanship. Liability under this policy extends for 24 months from date of shipment. Electrodes/probes are considered maintenance items and as such are warranted for six (6) months from the date of shipment of the controller. Electrodes/probes purchased as spare parts are warranted for 24 months from date of shipment. The manufacturer's liability is limited to repair or replacement of any failed equipment or part, which is proven defective in material or workmanship upon completion of the manufacturer's examination. This warranty does not include removal or installation costs and in no event shall the manufacturer's liability exceed the selling price of such equipment or part.

The manufacturer disclaims all liability for damage to its products through improper installation, maintenance, use, or attempts to operate such products beyond their functional capacity, intentionally or otherwise, or any unauthorized repair. The manufacturer is not responsible for consequential or other damages, injuries, or expense incurred through the use of its products.

The above warranty is in lieu of any other warranty, whether expressed or implied. The manufacturer makes no warranty of fitness or merchantability. No agent of ours is authorized to provide any warranty other than the above.



**USA**

Pulsafeeder, Inc.  
27101 Airport Rd.  
Punta Gorda, FL 33982  
USA  
(941) 575-3800  
[www.pulsa.com](http://www.pulsa.com)

**European Union (EU)**

**PULSAFEEDER-Europe**  
Via Kennedy, 12-20090  
Segrate—Milano— Italy