

MicroVision

MICROPROCESSOR – BASED
WATER TREATMENT
CONTROLLER

Installation Operation Manual



Table of Contents

1.	INTRODUCTION	4
2.	MICROVISION FEATURES	4
2.1	Toroidal Probe	4
2.2	Output Relays.....	5
2.3	Drum Levels.....	5
2.4	Flow Switch	5
2.5	4-20mA Output	6
2.6	Water Meter	6
2.7	Alarm Relay	6
3.	INSTALLATION	7
3.1	Opening The Enclosure.....	7
3.2	Location	8
3.3	Mounting Hardware	8
3.4	Sensor Installation.....	9
3.5	Flow Sensor Switch	9
3.6	TYPICAL INSTALLATION.....	10
4.	IMPORTANT SYMBOL INFORMATION	10
5.	ELECTRICAL WIRING	11
5.1	RELAY BOARD CONNECTIONS	12
5.2	Conduit Models (Wiring High Voltage)	12
5.3	LOW VOLTAGE CONNECTIONS	13
5.4	Flow Switch Input.....	14
5.5	Sensor (probe) Connection Input	14
5.6	Water Meter Input.....	14
5.7	Drum Level Input.....	14
5.8	4-20mA Output	14
5.9	Alarm Relay	14
6.	FRONT PANEL DESCRIPTION	15
6.1	Keypad Operation	15
7.	CONTROLLER PROGRAMMING.....	16
7.1	Menu Tree.....	16
7.2	Menu Navigation	17
7.3	Home screen.....	17
7.4	Main Menu.....	17
7.5	Status Screen	18
7.6	Configure Menu	18
7.7	Date/Time Menu	19
7.8	HOA Outputs Menu.....	19
7.9	Water Meter Menu.....	20
7.10	Languages Menu.....	20
7.11	Drum Levels Menu	20
7.12	Display Dampener	21
7.13	Rising/Falling Setpoint Option	21
7.14	Display Contrast Setting	22
7.15	Password Setting.....	22
7.16	Troubleshoot Screen	23
7.17	Software Version	23
7.18	Factory Reset Function	24
7.19	Settings Menu	25

7.20	Conductivity Menu	25
7.21	Inhibitor Menu	26
7.22	Inhibitor - Inhibitor Feed Mode Menu	27
7.23	Inhibitor - Inhibitor Feed Mode – Pulse Timer Menu.....	27
7.24	Inhibitor - Inhibitor Feed Mode – % Post Blowdown Menu	28
7.25	Inhibitor – Bio Tracking Menu	28
7.26	Biocide A or B Menu	29
7.27	Biocide A or B – Days/Weeks Menu.....	30
8.	Probe Calibration	31
9.	Factory Defaults	33
10.	TROUBLESHOOTING GUIDE.....	34
11.	MAINTENANCE	36
12.	SPECIFICATIONS	36
13.	GLOSSARY	38
14.	MOUNTING HOLE PATTERN (Footprint).....	41
15.	Factory Service Policy.....	42
16.	Warranty	42

1. INTRODUCTION

The *MicroVision* microprocessor based cooling tower controller has been designed to monitor and control Total Dissolved Solids (TDS) in terms of electrical conductivity measured in micro Siemens per centimeter ($\mu\text{S}/\text{cm}$). A set point of the desired conductivity is entered into the controller through the front panel. As this limit is exceeded, a bleed valve is opened via an onboard control relay. The system's water, with higher concentrations of TDS, is bled resulting in fresh make-up water being added, reducing the concentration of TDS in the cooling system.

In addition to the bleed relay, *MicroVision* has three (3) other onboard control relays assigned as follows:

Relay 1 - Bleed control

Relay 2 - Inhibitor timer (selectable)

Relay 3 - Biocide A

Relay 4 - Biocide B

2. MICROVISION FEATURES

2.1 Toroidal Probe

MicroVision uses a toroidal probe for conductivity measurement. The measurement is made by passing an AC current through a toroidal drive coil, which induces a current in the electrolyte solution (see Fig.1). This induced current in turn, induces a current in a second toroidal coil, called the pick-up toroid. The amount of current induced in the pick-up toroid is proportional to the solution conductivity.

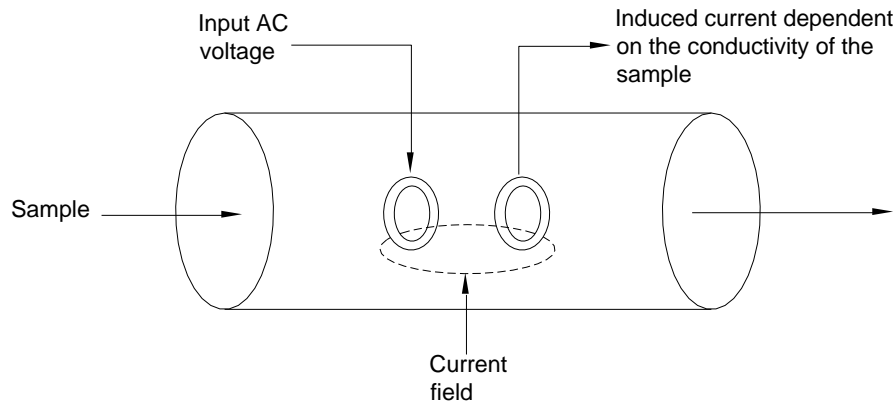

Fig. 1

The main advantage of toroidal conductivity is that the toroidal coils are not in contact with the solution. They are encased in a polymeric material or are external to a flow through cell.

2.2 Output Relays

The control of the four HANDS – OFF – AUTO (HOA) output relays can be controlled using the HOA menu.

RELAY STATUS	LED COLOR
ON (FORCED ON FOR 5 MIN.)	AMBER
OFF	RED
AUTOMATIC 'ON'	GREEN
AUTOMATIC 'OFF'	OFF

2.3 Drum Levels

Three (3) onboard dry contact inputs serve as Drum Level inputs. When a low level is detected (switch closure), the unit will go into an Alarm state and the low drum's identity will be displayed on the screen.

2.4 Flow Switch

MicroVision has a dry contact flow switch input that will de-activate all of the control output relays upon a no-flow indication. An Alarm condition will be indicated and "No Flow" will be displayed. This input is active closed:

Open = no flow; closed = flow.



If a flow switch input or other alarm condition exists, the four (4) LED's will flash until the alarm condition is cleared.

2.5 4-20mA Output

Connect your 4-20mA equipment to J8 (Fig. 7) pins + and -. The 4-20mA output uses 24VDC as a supply voltage. See the "Conductivity Menu" section (Page 24) for setting up and calibrating the 4-20mA output.

2.6 Water Meter

MicroVision has a dedicated water meter that is capable of reading a dry contact or Hall effect type water meter. Through programming this input can be used to feed inhibitor as well as totalizing water consumption.

2.7 Alarm Relay

MicroVision has a dedicated dry contact relay that can be used to interface with process control equipment or visual indicators. This relay is un-powered.

3. INSTALLATION



Input power cord must be disconnected from power source prior to opening the product's enclosure.

3.1 Opening The Enclosure¹

Loosen the four (4) screws on the front of the controller and carefully swing the top of the case to the right (*Fig. 2*).

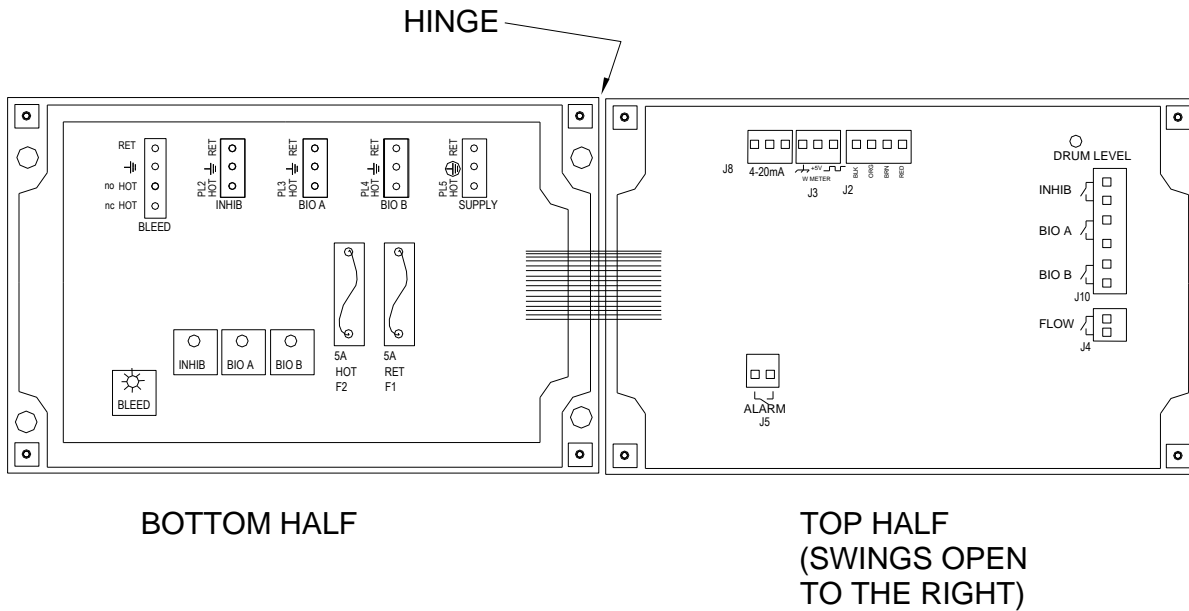



Fig. 2

¹ Trained service personnel are required for all electrical connections. This product does not contain operator serviceable parts.

3.2 Location

Select a mounting location convenient to grounded electrical and plumbing connections. It is recommended that you mount the controller on a wall or other vertical surface with adequate lighting at a comfortable level. A mounting-hole template is supplied with your controller. Installation should comply with all national, state, and local codes.

 **WARNING** AVOID LOCATIONS WHERE THE CONTROLLER WOULD BE SUBJECTED TO EXTREME COLD OR HEAT {LESS THAN 0°F (-17,8°C) OR GREATER THAN 122°F (50°C)}, DIRECT SUNLIGHT, VIBRATION, VAPORS, LIQUID SPILLS, OR EMI (ELECTROMAGNET INTERFERENCE; E.G., STRONG RADIO TRANSMISSION AND ELECTRIC MOTORS.)

 **WARNING** SAFETY PROTECTION PROVIDED BY THE EQUIPMENT MAY BE IMPAIRED IF THE EQUIPMENT IS USED IN A MANNER NOT SPECIFIED BY THE MANUFACTURER. THIS CONTROLLER IS INTENDED FOR INDOOR USE ONLY.

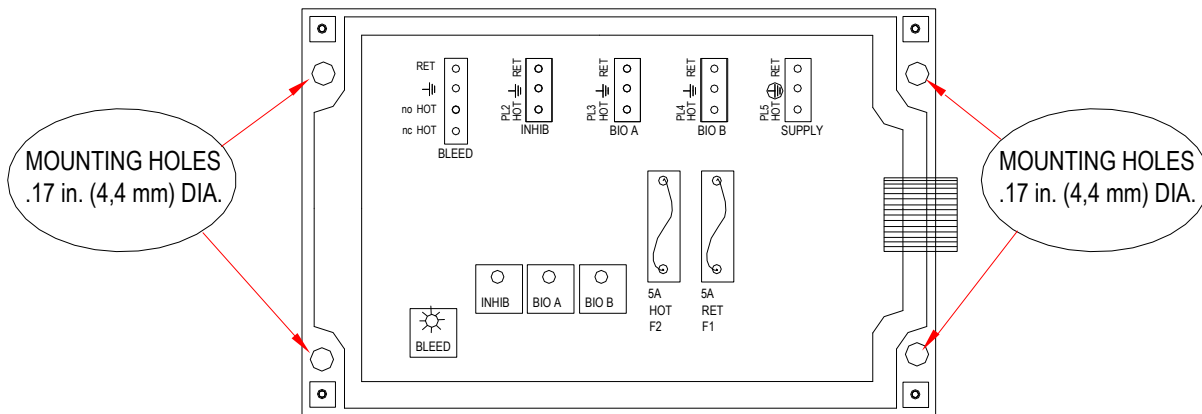

Fig.

3

Mount the bottom half of the controller using the four (4) holes provided (Fig. 3).

3.3 Mounting Hardware

For panel mounts without threaded inserts, four number 8 self tapping screws are the minimum recommendation.

For panel mounts with threaded inserts, four 8-32 screws are the minimum

recommendation.

Panel mount hardware should support 25lbs. For hole locations, see the mounting hole pattern (*Fig. 9*) found on the page 39 of manual.

3.4 Sensor Installation

The controller is supplied with a temperature compensated toroidal conductivity sensor (probe). Install the sensor at some point in your process where chemical and water are thoroughly mixed. The probe should also be located in a position where adequate flow is going around and through the probe (*Fig. 4*) so that the controller will be able to display a good measurement.

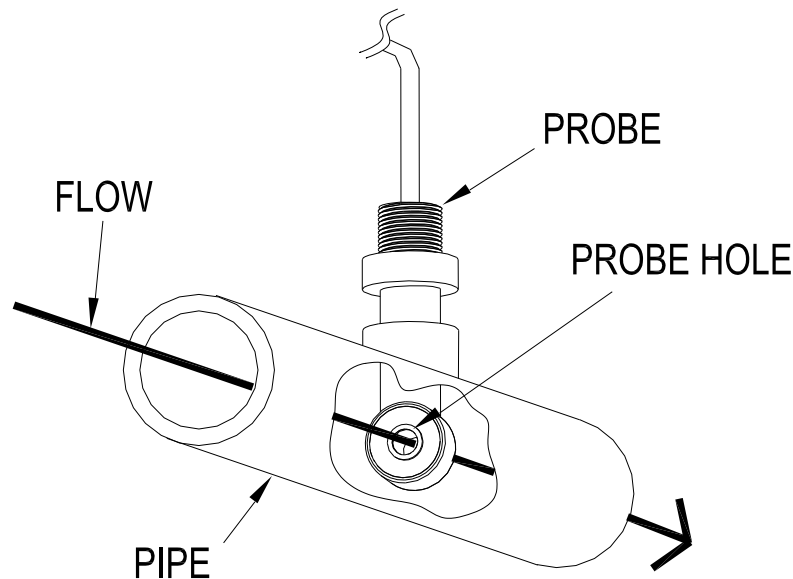

Fig. 4

3.5 Flow Sensor Switch

If your controller is provided with a flow switch, install the flow switch so that flow enters into the bottom of the flow switch tee, and out of the side of the tee. The flow switch must always be installed in a vertical position so that the sensor wire is coming out of the top, and the internal (red) flow shuttle is able to rise when there is flow and drop when there is no flow. The flow switch is activated when 1 GPM (3,8 LPM) is going through it, and is deactivated when the flow drops below 1 GPM (3,8 LPM).

3.6 TYPICAL INSTALLATION

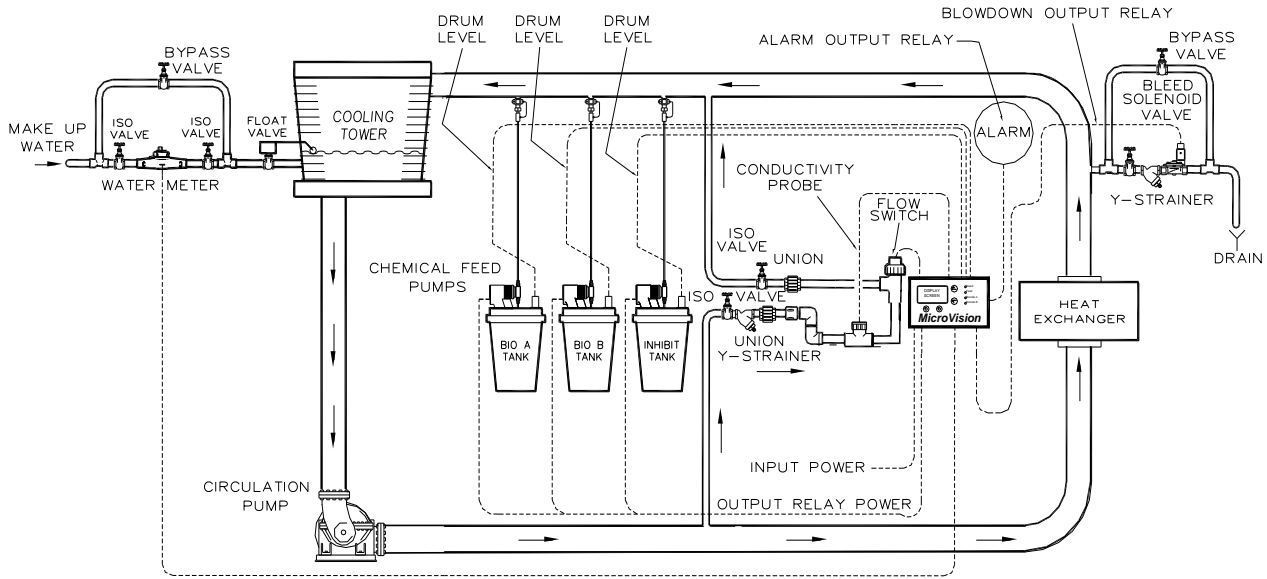

Fig. 5

4. IMPORTANT SYMBOL INFORMATION



Warning indicates a condition that could cause damage to both the equipment and the personnel operating it. Pay close attention to any warning.



Primary Supply Ground must be connected to earth ground for safe operation of your controller.



Chassis Ground – Connect your equipment's ground wire here for safe operation of your external devices.

5. ELECTRICAL WIRING²



Controller must be wired in accordance with all applicable electrical codes.



Input power must be 120 or 220VAC Single Phase.



Trained service personnel are required for all electrical connections. This product does not contain operator serviceable parts.



Devices attached to any Relay connection must be Single Phase and rated for the same voltage as the input voltage to the product. (e. g. 120VAC MicroTrac controllers support 120VAC relay attached devices exclusively and 220VAC MicroTrac controller support 220VAC relay attached devices exclusively.)



Input power cord must be disconnected from power source prior to opening the product's enclosure and making any electrical connections.



The controller should be connected to a dedicated power branch (i.e., its own wiring, circuit breaker, etc.). For best results, the ground should be independent (true earth) not shared.



A switch or circuit-breaker, marked as the unit's disconnecting device should be included in the installation. It should be in close proximity to the unit and easily reached by the user.

The *MicroVision* electronic input circuitry is fuse protected on both the hot and neutral inputs using a replaceable five amp fuse (*Fig .6*).

For additional protection of your instrument, use of a surge protector is recommended.

Pre-wired controllers are supplied with a 3-wire grounded power cord and 3-wire grounded receptacle cords for all controlled line voltage outputs.

² Trained service personnel are required for all electrical connections. This product does not contain operator serviceable parts.

5.1 RELAY BOARD CONNECTIONS³

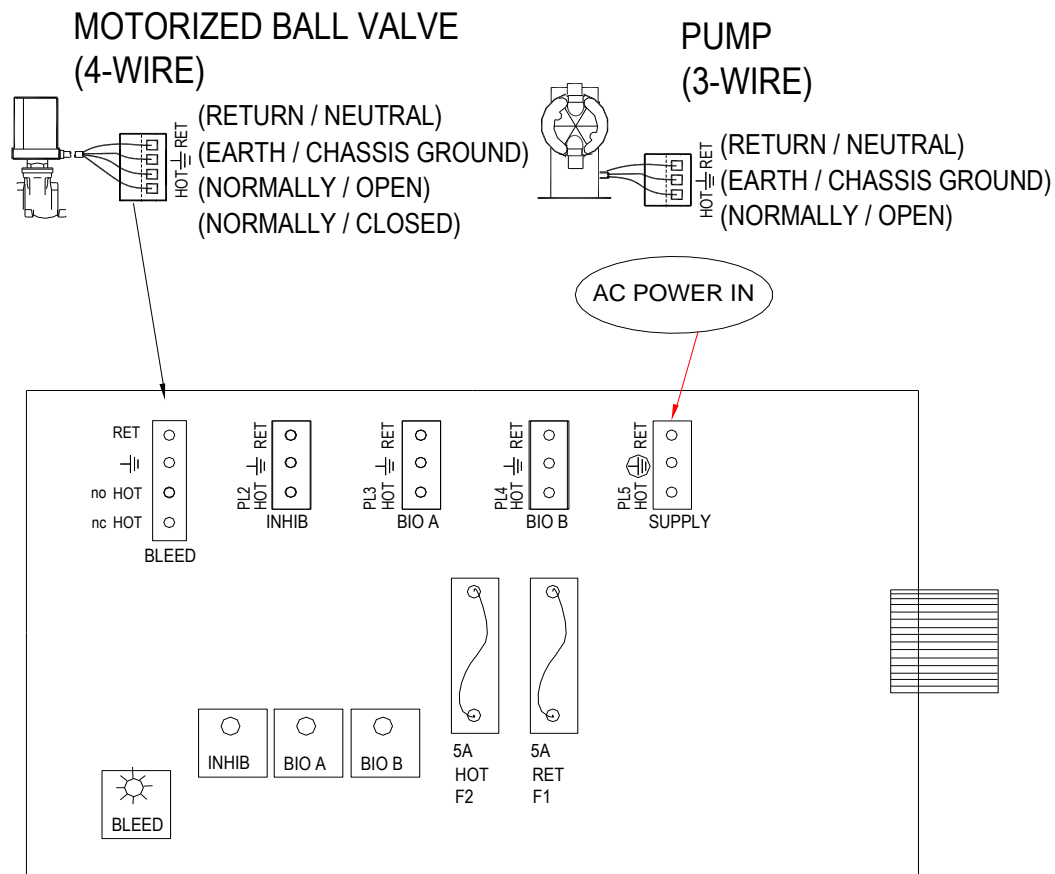

Fig. 6

5.2 Conduit Models (Wiring High Voltage)⁴



WARNING

Devices attached to any Relay connection must be Single Phase and rated for the same voltage as the input voltage to the product. (e. g. 120VAC MicroTrac controllers support 120VAC relay attached devices exclusively and 220VAC MicroTrac controller support 220VAC relay attached devices exclusively.)

Do not apply power until this condition is verified.

Conduit controllers have openings for conduit connections for hard wiring. See Fig. 6 for input and output power connections. Use only 18 AWG (1,2 mm²) stranded wire

³ Trained service personnel are required for all electrical connections. This product does not contain operator serviceable parts.

⁴ Trained service personnel are required for all electrical connections. This product does not contain operator serviceable parts.

for conduit power and load connections. Supply (input) power is connected via **PL5** located on the relay board (Fig. 6). The top part of this terminal block is removable to allow for easy access to the connector's three (3) screws.



Make sure that all conduit connections are water tight.

The four (4) output relay terminal blocks are identified as: **PL1 (Bleed), PL2 (INHIB), PL3 (BIO A), and PL4 (BIO B)**. These terminal blocks can be removed in the same manner as **PL5**. The Bleed relay has a N.O. and a N.C. connection, the others are only N.O.

5.3 LOW VOLTAGE CONNECTIONS⁵

The low voltage connections are found on the low voltage (right side) board (Fig. 6). Use 22-24 AWG (.76 mm²) wire for: flow switch, drum levels, dry alarm, and water meter connections. These signal wires must be run separate from AC power lines.

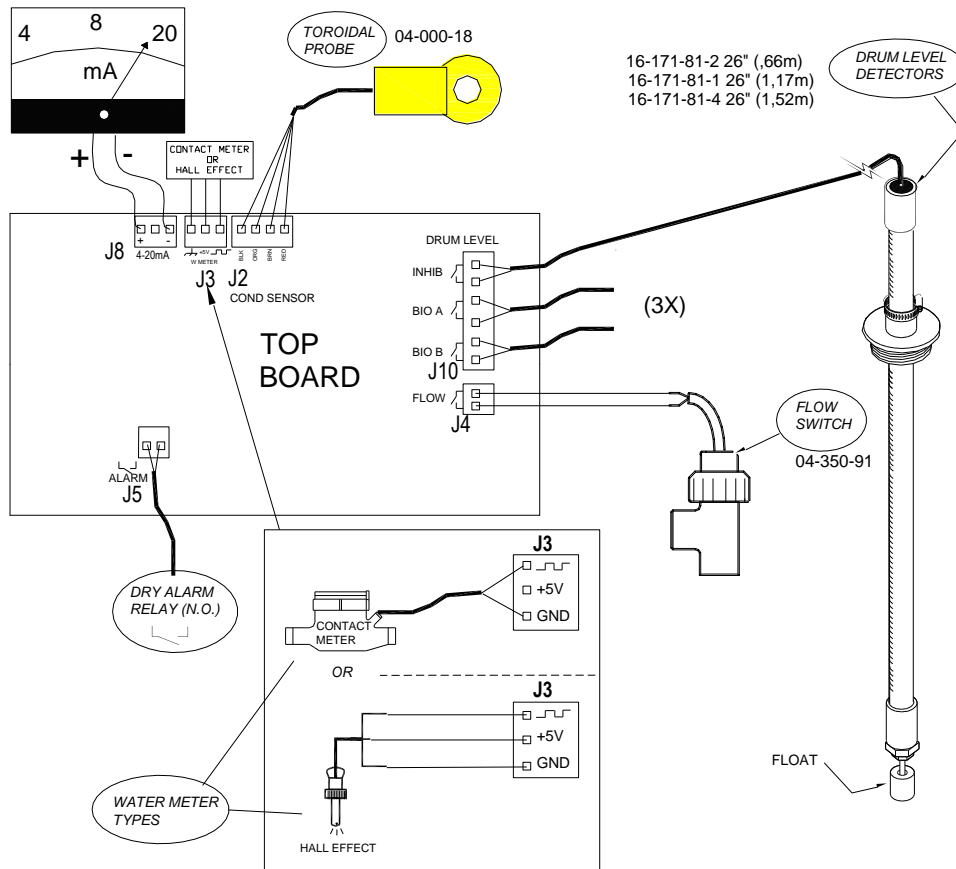

Fig. 7

⁵ Trained service personnel are required for all electrical connections. This product does not contain operator serviceable parts.



Low voltage signal wires, e.g., water meter, must be run separate from AC power lines. These connections will be covered in the **Low Voltage** section of the manual.

5.4 Flow Switch Input

It is recommended that a flow switch or auxiliary dry contact be used to make outputs inoperative when the cooling tower is shut down. Connect detection wires to **J4** (Fig. 7), to use this interlock feature. This is active – closed:
open = no flow; closed = flow.



If you do not have a flow switch, a jumper wire must be connected across J4.

5.5 Sensor (probe) Connection Input

The controller is supplied with a toroidal conductivity sensor. Connect the wires to **J2** as shown (Fig. 7).

5.6 Water Meter Input

Connect your water meter to **J3** of the top board. For proper connections, refer to (Fig. 7) for your meter type, Hall effect or contacting head.

5.7 Drum Level Input

The drum level connections are made to the top board via **J10** (Fig. 7). They are labeled as, **INHIBIT, BIO A, and BIO B**. These are active closed: closed = low level; open = level is OK.

5.8 4-20mA Output

Connect your 4-20mA equipment to J8 (Fig. 7) pins + and -. The 4-20mA output uses 24VDC as a supply voltage. See the “Conductivity Menu” section (Page 24) for setting up and calibrating the 4-20mA output.

5.9 Alarm Relay

Use J5 to connect your alarm reporting equipment. This relay will close when an alarm condition exists and will open when no alarm conditions are present. See the Trouble Shooting Guide (Page 34) for a description of alarm codes and their probable causes.

6. FRONT PANEL DESCRIPTION

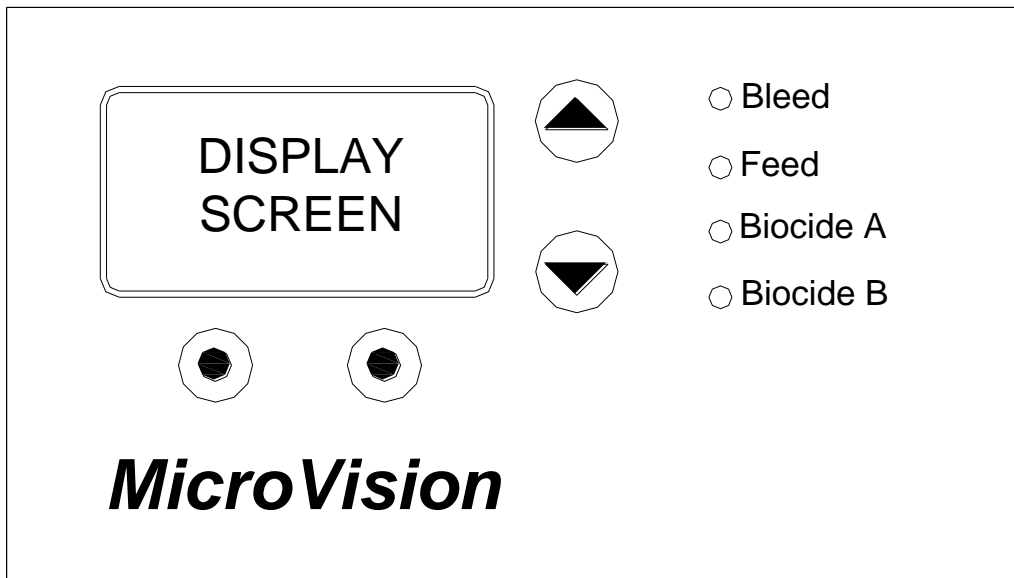

Fig. 8

6.1 Keypad Operation

UP/DOWN - Dual function keys. Used to move the select (highlighted) box and to increase and decrease values.

○ ○ - Soft keys used for various functions depending on currently displayed screen. The key's function appears above the key on the display.

7. CONTROLLER PROGRAMMING

7.1 Menu Tree

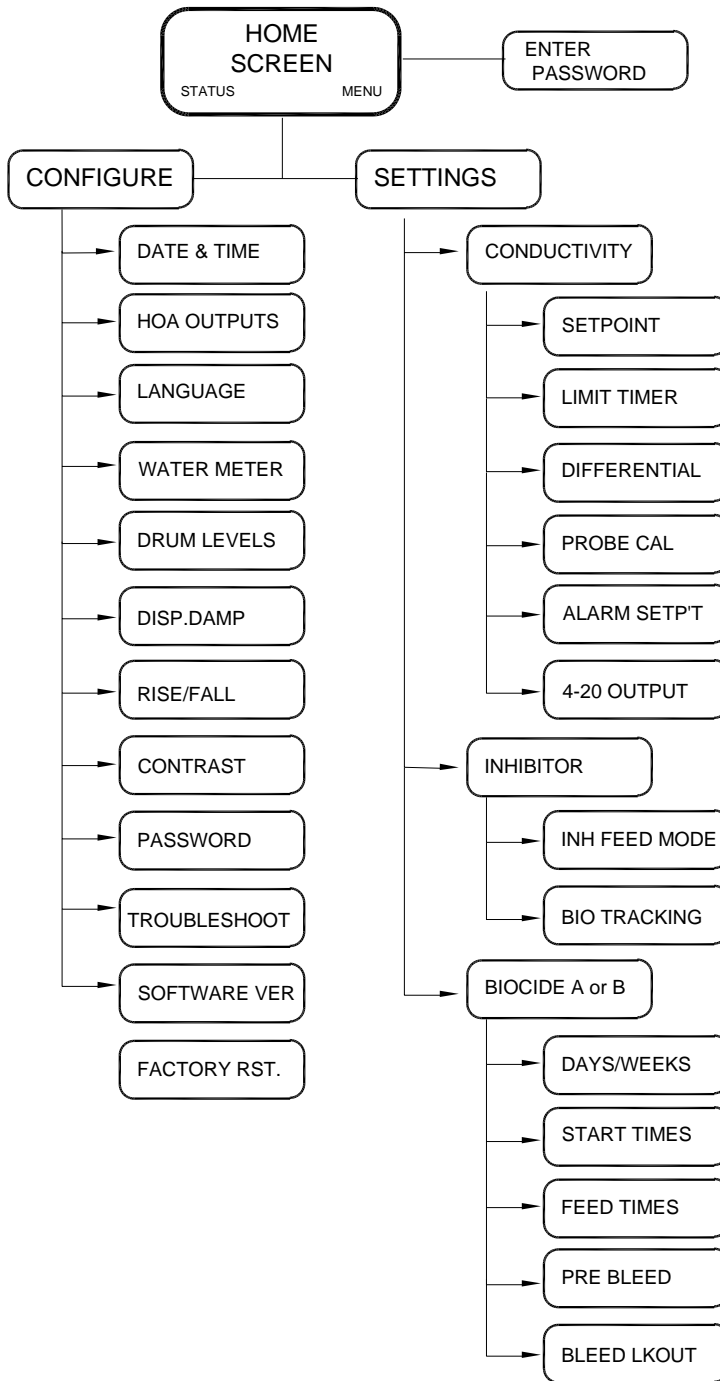

7.2 Menu Navigation

Microvision uses four front panel buttons to navigate through the different menus. Use these buttons to move up and down within a list of options or move right and left to enter or change parameter values. In some cases the Microvision display will prompt you to press the different buttons to assist you in selecting or changing data.

Some menus may display highlighted menu options or a checkmark (✓) next to a menu option. The highlighted menu option is used to indicate that another menu will be displayed if this option is chosen. The checkmark indicates that a particular control mode has been selected.

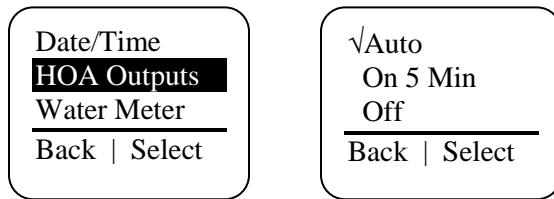

7.3 Home screen

This screen is displayed during normal operation when there are no alarm conditions on the Microvision. If an alarm condition occurs an alarm message will flash on the screen. The four LED's to the right of the display will also flash indicating an alarm has occurred.

The Microvision will return to this screen home screen if no buttons are pressed for five minutes after entering a menu.

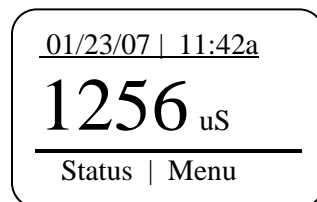

7.4 Main Menu

The Main menu is the starting point for all subsequent menus.

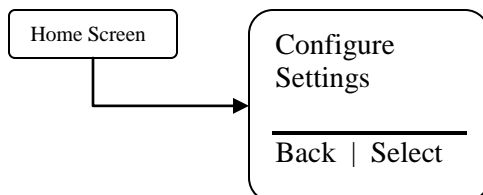

Configure – This menu allows you to set the time and date, display contrast, water meter, etc.

Settings – This menu allows you to set the conductivity, inhibitor feed modes, and biocide control timers.

7.5 Status Screen

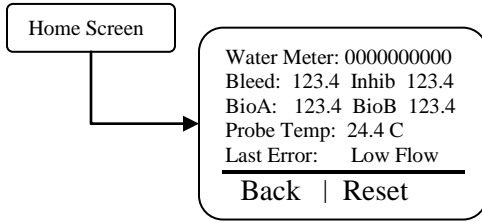

This screen shows the real-time data relating to the controller. This screen can be used to log the amount of time a particular output was energized since it was last reset.

Below is a description of each of the data fields:

Water Meter – The amount of water that has been registered by the controllers water meter input.

Bleed – The amount of time, in hours, the bleed output was energized since it was last reset.

Inhib – The amount of time, in hours, the inhibitor output was energized since it was last reset.

BioA – The amount of time, in hours, the biocide-A output was energized since it was last reset.

BioB – The amount of time, in hours, the biocide-B output was energized since it was last reset.

Probe Temp – Current probe temperature in Celsius.

Last Error – Shows the most recent error that was displayed on the controller.

Pressing the reset key will cause the hour timers and water meter to reset to zero.

7.6 Configure Menu

From the Configure menu you can select many different system configuration options.

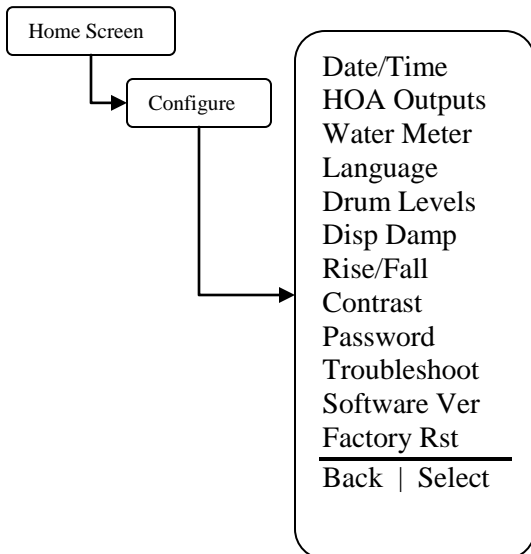

- Date/Time** – Set the current date, date format, time, and time format.
- HOA Outputs** – Manually control the four output relays.
- Water Meter** – Set the water meter type and volume.
- Language** – Change the controller displayed language.
- Drum Levels** – Set the control output mode when a drum level goes low.
- Display Dampener** – Set the display and control update period.
- Rise/Fall** – Select between a rising or falling Setpoint mode of operation.
- Contrast** – Set the display contrast.
- Password** – Set the user password.
- Troubleshoot** – View the signal inputs in real-time to diagnose wiring problems.
- Software Version** – Displays the current software version.
- Factory Restore** – Restore the parameters to factory default.

7.7 Date/Time Menu

From the Date/Time menu you can set the data and time as well as the date and time display formats.

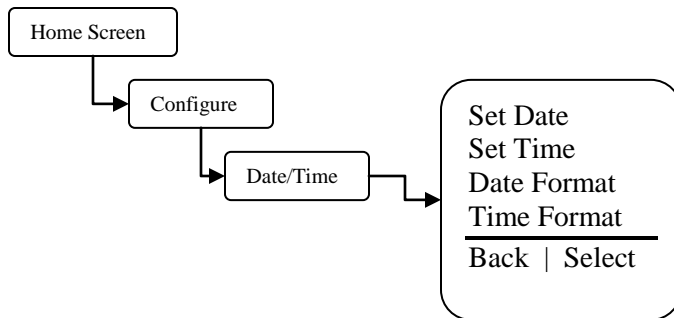

- Set Date** – Set the current date.
- Set Time** – Set the current time.
- Date Format** – Pick the day/month/year format.
- Time Format** – Pick the 12-hour or 24-hour time of day format.

7.8 HOA Outputs Menu

From the HOA Outputs menu you can manually set the four relay control outputs. This is useful for servicing chemical pumps or troubleshooting electrical problems. You must first select the relay output to be controlled then select the relay state.

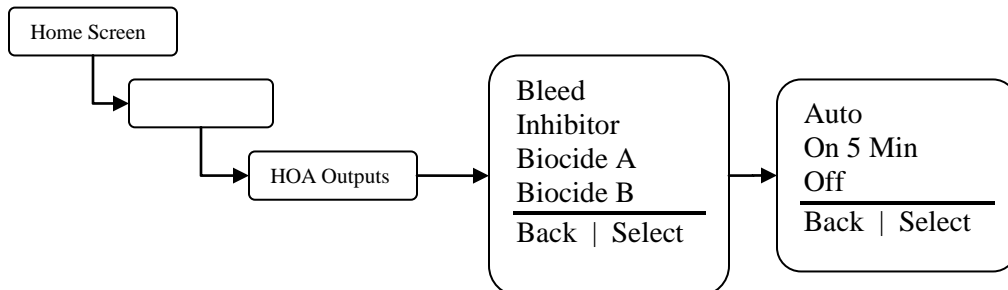

- Bleed** – Force the bleed control output on or off.
- Inhibitor** – Force the inhibitor control output on or off.

- Biocide A** – Force the biocide A control output on or off.
- Biocide B** – Force the biocide B control output on or off.
- Auto** – Return the control output to normal operation.
- On 5 Min** – Energize the control output for five minutes.
- Off** – De-energize the control output indefinitely.



Forcing the output to Auto may cause the control output to energize without warning.

7.9 Water Meter Menu

From the Water Meter menu you select what type of water meter the controller is attached to. Once the meter type has been entered the next screen will ask you for the gallons/liters per pulse or “K-factor” depending on the meter type. You can also select between gallons or liters for units of measure and view or reset the water meter totalizer.

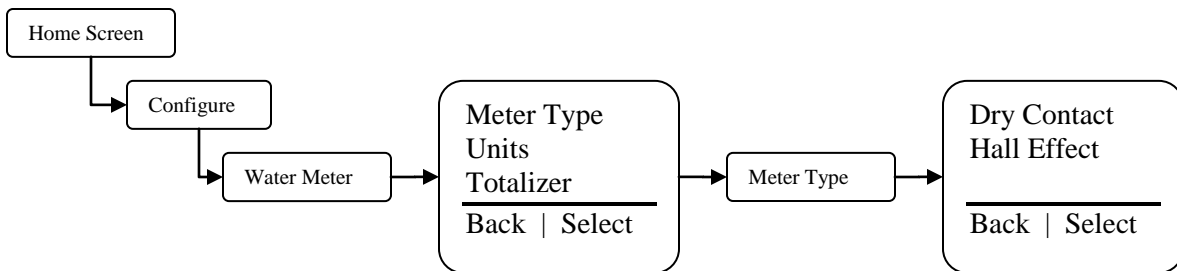

- Meter Type** – Select between a dry contact or Hall-effect water meter. Once the type is selected enter the resolution or volume per pulse.
- Units** – Select gallons or liters as a unit of measure for water calculations.
- Totalizer** – This displays the current amount of water the controller has counted. You can reset the totalizer from this menu.

7.10 Languages Menu

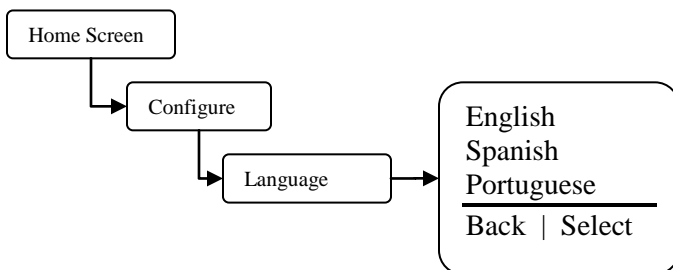

7.11 Drum Levels Menu

From the Drum Level menu you select how you want the chemical pump control output to respond to a low drum level indication. Your choices are to allow the pump to continue to run or have the pump stop when its drum level goes low. There is one drum level input for each pump control output.

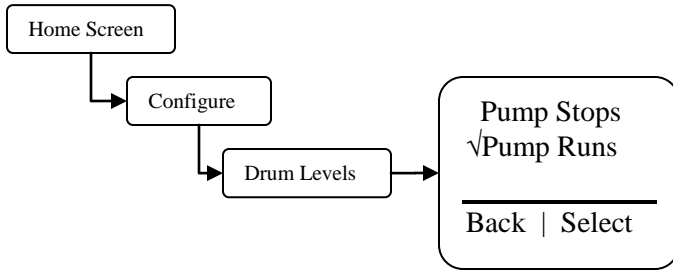

Pump Stops – Selecting this mode causes the inhibitor, biocide A, or biocide B outputs to de-energize when their drum level goes low.

Pump Runs – Selecting this mode causes the inhibitor, biocide A, and biocide B outputs to remain energized even though their drum level has gone low.



When a drum level goes low the controller will go into alarm regardless of this setting. Re-filling a low drum may cause the pump control output to energize without warning.

7.12 Display Dampener

From the Display Dampener setting option you select how often you want the actual conductivity reading updated on the Home Screen and dampening of the controller response to sudden changes in conductivity.

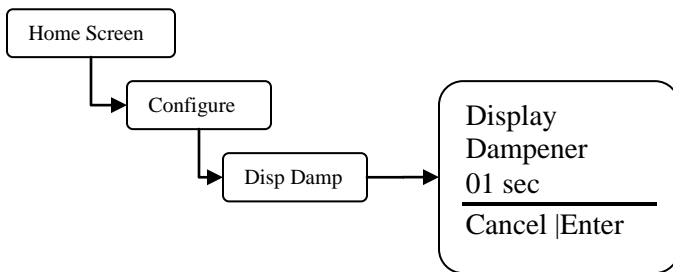

Display Dampener – Set this value to the number of seconds you want the controller to dampen the displayed conductivity and controller response.



The controller takes a conductivity reading every second. Increasing this value above one second causes the controller to average the readings, hence, slowing down the control functions.

7.13 Rising/Falling Setpoint Option

From the Rise/Fall setpoint option you select which direction the conductivity will tend to go in the process being controlled. If the Microvision is controlling a cooling tower use the Rising setpoint option.

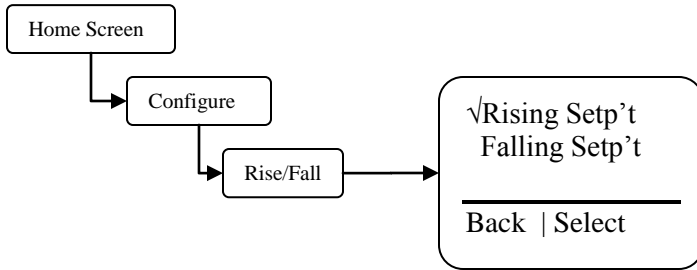

Rising Setpoint – Select this option if a cooling tower is being controlled.
Falling Setpoint – Select this option if the conductivity tend to fall as a result of the process.

7.14 Display Contrast Setting

From the Display Contrast setting you adjust the display contrast to give the best clarity and readability of the display screen.

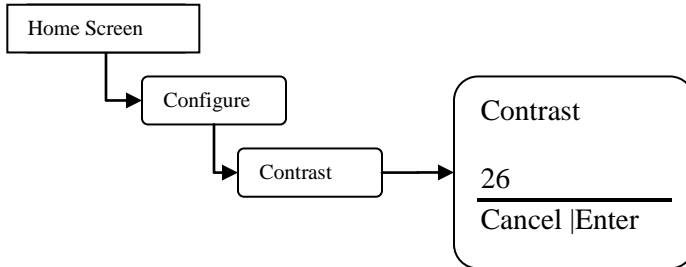

Contrast – Adjust this value up or down to give you the best display contrast.

7.15 Password Setting

From the Password setting you select the user password that will be required to gain access to the Configuration and Settings menus. Once the password is set to anything other than 0000 (4-zeros) the password feature is enabled. To disable password protection return the password to 0000 (4-zeros).

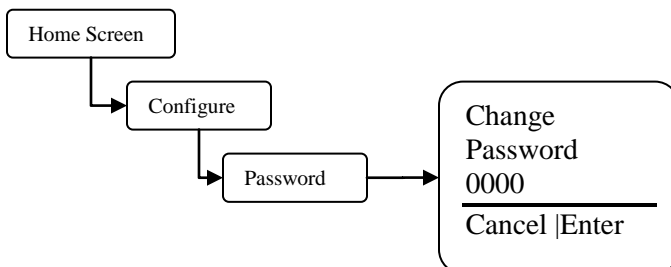

Password – Set the user password.



Once the password is set the controller will require a password to access any menus. If the password is lost or unknown you will have to call technical service to gain access to the

controller menus. Please have the controller in front of you when you place the call.

7.16 Troubleshoot Screen

From the Troubleshoot Screen you can view the Microvision control inputs in real-time. This is a great tool for checking the correct operation of sensors that are attached to the controller.

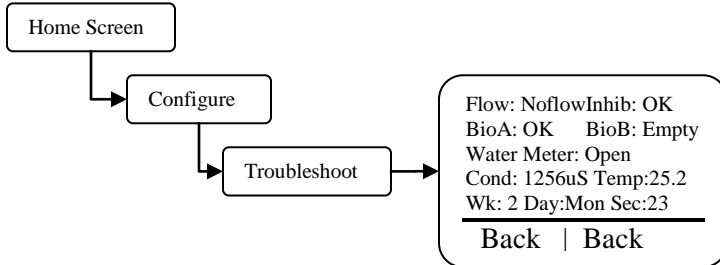

- Flow** – Water flow switch input (J4 pins 1-2). Flow=closed, Noflow = open.
- Inhib** – Inhibitor drum level input(J10 pins 1-2). Empty=closed, OK=open.
- BioA** – Biocide A drum level input(J10 pins 3-4). Empty=closed, OK=open.
- Inhib** – Biocide B drum level input(J10 pins 5-6). Empty=closed, OK=open.
- Water Meter** – Water meter input (J3 pins 1-3). Open=contact open, closed=contact closed.
- Cond** – Probe conductivity reading.
- Temp** – Probe temperature.
- Wk** – Revolving week number between one and four. This is used in the biocide Days/Weeks settings.
- Day** – Day of week. This is used in the biocide Days/Weeks settings.
- Sec** - Current clock seconds.



While this screen is displaying information the controller is still functioning normally and relay outputs may energize without warning due to changing signal inputs.

7.17 Software Version

From the Software Version screen you can view the current software that is running in the Microvision controller.

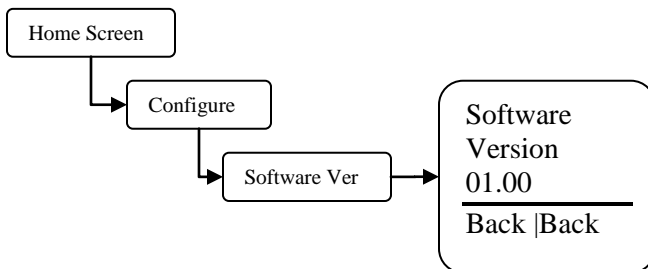

Software Version – This screen displays the current software version.

7.18 Factory Reset Function

From the Factory Reset Function screen you can force the controller to reset all of its internal parameter to the factory default values.

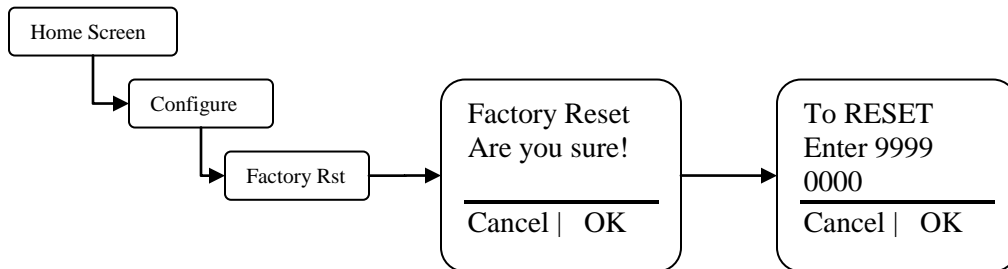

Use this function to reset the controller back to the factory defaults.



Be absolutely certain you want to reset all the parameters back to the factory defaults. Once the reset takes place there is no way to retrieve the previous parameters.

7.19 Settings Menu

From the Settings menu you access the conductivity, inhibitor feed, and dual biocide feed parameter sections.

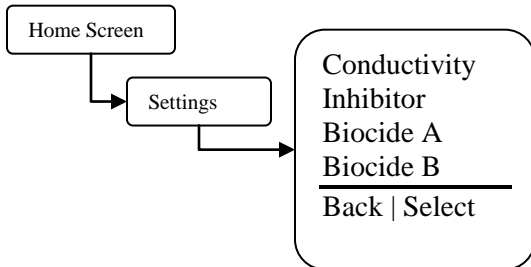

Conductivity – Set the conductivity setpoint, differential, probe calibration, alarms, and 4-20ma output parameters.

Inhibitor – Set the inhibitor feed and biocide tacking modes.

Biocide A – Set the biocide A days and weeks, start times, feed time, and bleed options.

Biocide B – Set the biocide B days and weeks, start times, feed time, and bleed options.

7.20 Conductivity Menu

From this menu configure the parameters that trigger the bleed control output and optionally the inhibitor feed functions. Additionally, the conductivity probe calibration, alarm setpoints, and the scalable 4-20ma output functions are also configured in this section.

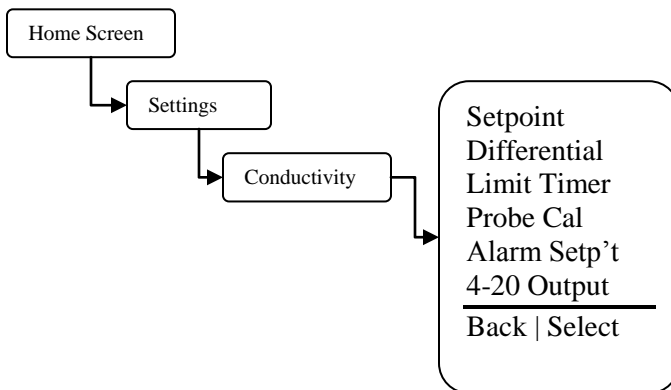

Setpoint – Set the conductivity setpoint. This is the conductivity point where a bleed function will begin. Once the conductivity has reached this value the bleed function will begin.

Differential – The differential setting controls when the bleed function stops. This value subtracted from the conductivity setpoint causes the bleed function to stop.

Example: Setpoint=1200, Differential=100, the bleed function begins when the conductivity reaches 1200 and ends when the conductivity reaches 1100.

Limit Timer – Set this value to the maximum amount of time the bleed output can stay energized before a Bleed Limit alarm is reported. The limit time setting only reports the alarm and does NOT turn off the bleed output. If the next bleed cycle completes without an alarm the alarm will clear itself. Setting this value to 00:00 turns off this function.

Probe Calibration – Use this function to calibrate the probe. Enter the calibrated conductivity value that you would like the controller to display.



The conductivity probe is very sensitive to temperature changes. Allow the probe roughly 10 minutes to adjust to the temperature of the test solution or sample. Calibrating the probe without allowing the probe to equilibrate to the sample temperature could result in erroneous controller conductivity readings.



Only use a calibration meter that incorporates temperature compensation when performing a probe calibration.

Alarm Setpoint – Pick the type of conductivity alarm tracking you want to use.

Track Setpoint – Use this type if you want an alarm when the conductivity reaches above or below the conductivity setpoint an equal amount.

Example: Setpoint=1200, Track Setpoint=200, an alarm will be reported when the conductivity reaches above 1400 or below 1000.

Independent Setpoint – Use this type if you want to specify an upper and lower conductivity value for alarm reporting.

Example: Setpoint=1200, low=900, high=1450, an alarm will be reported when the conductivity reaches above 1450 and below 900.

4-20 Output – Use this option to configure how you want the 4-20ma output to behave with respect to the conductivity reading.

Adjust Range – Use this option to set the low and hi conductivity readings used to scale the 4-20ma output.

Example: Low Range=500, High Range=2000, when the conductivity reading is 500 the 4-20 ma output would be 4ma, when the conductivity reading is 2000 the 4-20ma output would be 20ma.

Calibrate Output – Use this option to calibrate or “fine-tune” the 4-20ma output. You can adjust both the 4ma and 20ma settings a small amount to compensate for un-calibrated downstream meters or displays.

7.21 Inhibitor Menu

From this menu configure the parameters that control the inhibitor chemical feed control output.

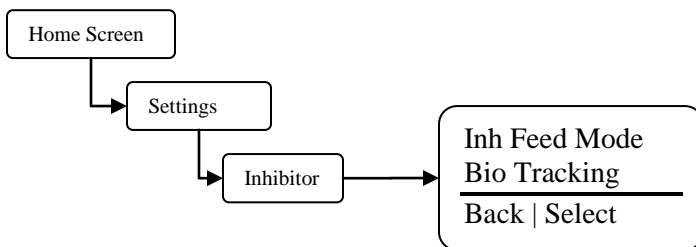

7.22 Inhibitor - Inhibitor Feed Mode Menu

From this menu pick the mode that the inhibitor feed will follow.

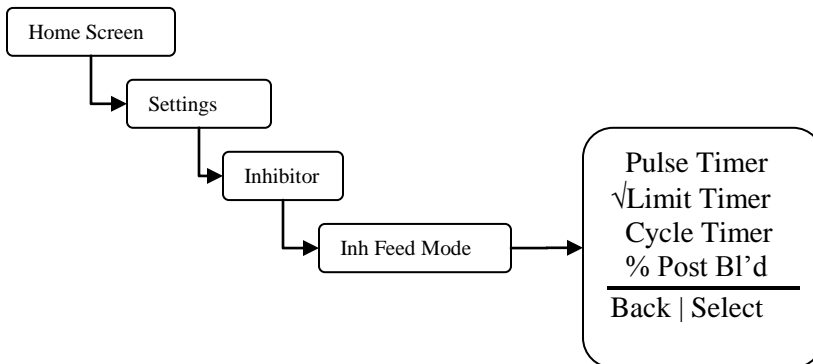

Pulse Timer – See the menu for this function in the following section.

Limit Timer – Set this value to the maximum amount of time you want the inhibitor to feed while the bleed function is running. If this time is exceeded the controller will go into alarm and the inhibitor feed control output will de-energize.

Cycle Timer – Set the inhibitor feed time period and percentage of the time period.
Example: Cycle Time=60minutes, % Minutes to run=10, the inhibitor will feed for 10% of 60 minutes, or 6 minutes every 60 minutes.

%Post Blowdown – See the menu for this function in the following section.

7.23 Inhibitor - Inhibitor Feed Mode – Pulse Timer Menu

From this menu configure how you want the inhibitor to feed while in pulse timer mode. This mode uses the water meter input to cause a counter to accumulate a certain volume of water before the inhibitor is feed. Once the accumulated volume is reached the inhibitor is feed for the programmed Feed Time.

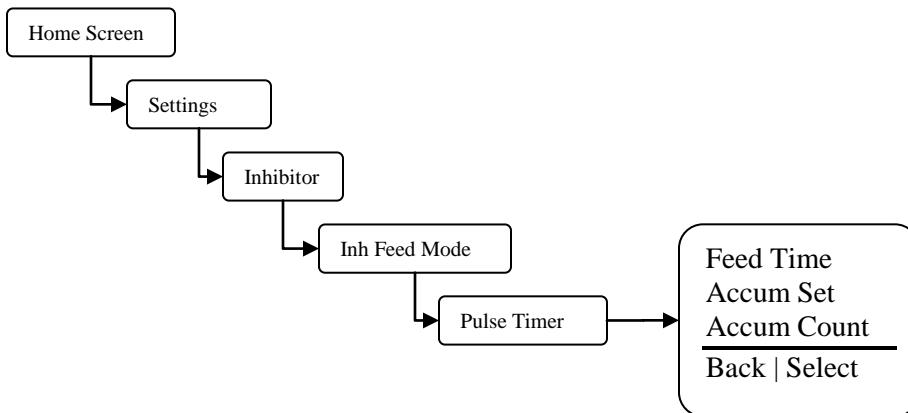

Feed Time – Set this value to the amount of time you want the inhibitor to feed when the water meter accumulator reaches its target.

Accumulator Set – Set this value to the amount of water that needs to accumulate prior to an inhibitor feed. The units will be in gallons or liters depending on what you set the water meter units to.

Accumulator Count – This is the current running count of the inhibitor water meter accumulator.

7.24 Inhibitor - Inhibitor Feed Mode – % Post Blowdown Menu

From this menu configure how you want the inhibitor to feed. This timer keeps track of the time the bleed relay is turned on. When the bleed shuts off, the timer begins feeding for a percentage of the bleed time. The percentage is adjustable in 1% increments from 0 to 99% of the blowdown time. This timer also includes a limit timer to prevent overfeed.

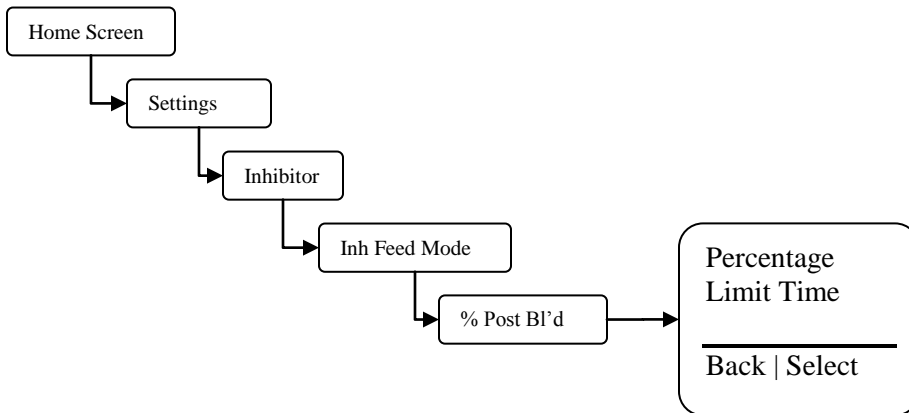

Percentage – Set this value to the amount of time, as a percentage, you want the inhibitor to feed after a blowdown function has completed.

Example: % of Bleed=25%, the most recent blowdown cycle took 20 minutes, the inhibitor will now feed for 25% of 20 minutes, or 5 minutes.

Limit Time – Set this value to the maximum amount of time you will allow inhibitor to feed after a blowdown cycle has completed. Setting the timer to 00:00 turns off this function.

7.25 Inhibitor – Bio Tracking Menu

From this menu configure how you want the inhibitor to feed when a biocide may be feeding.

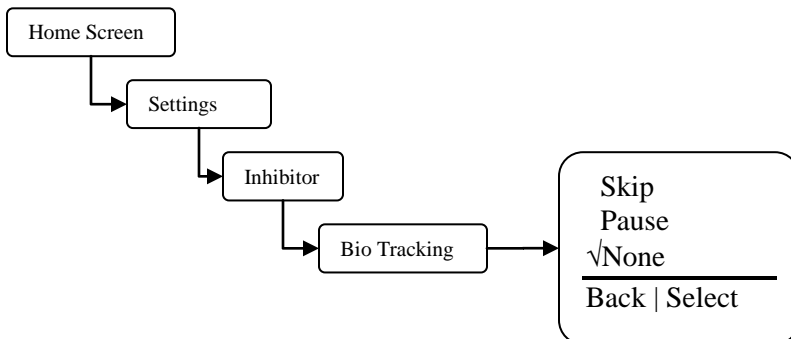

Skip – Choose this option if you want the inhibitor to skip a feed cycle if a biocide happens to be feeding.

Pause – Choose this option if you want the inhibitor feed cycle to pause or delay until the biocide feed cycle is complete. When the biocide feed cycle is complete the inhibitor will then feed.

None – Choose this option if you want the inhibitor to feed regardless of what the biocide feed cycles are doing.



Any inhibitor feed time that was paused or skipped due to a biocide feed cycle will not be added to the next inhibitor feed cycle.

7.26 Biocide A or B Menu

From this menu configure how often and the duration you want the biocide to feed. This controller can also perform a pre-bleed, using a conductivity minimum and a fixed time, and bleed-lockout function with each biocide feed.

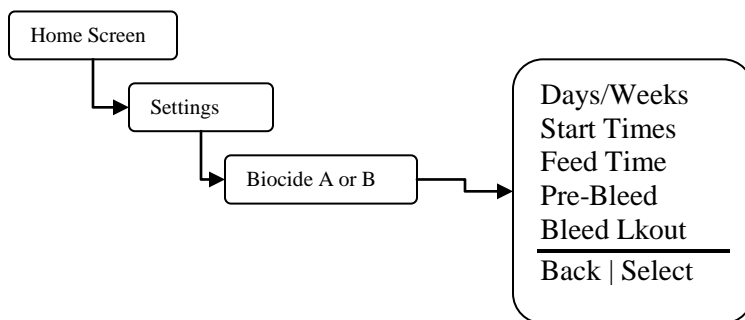

Days/Weeks – Set the days and weeks you want the biocide to feed. See the next section for details on how to set the days and weeks.

Start Times – Set up to four start times. Setting the value to 00:00 means the start time is ignored.

Feed Time – Set this value to the amount of time you want the biocide to feed each time a feed cycle is started.

Pre-Bleed – Set the pre-bleed time to the maximum amount of time you want the pre-bleed function to force a bleed cycle without reaching the conductivity minimum. Set the conductivity minimum to the value you want the conductivity to reach before the bleed cycle finishes and the biocide is feed.

Bleed Lockout – Set this value to the amount of time you want to lock-out a bleed function after a biocide feed cycle has started.

7.27 Biocide A or B – Days/Weeks Menu

From this menu configure the days and weeks the biocide will feed. Any combination of days and/or weeks is acceptable for each biocide feed timer.

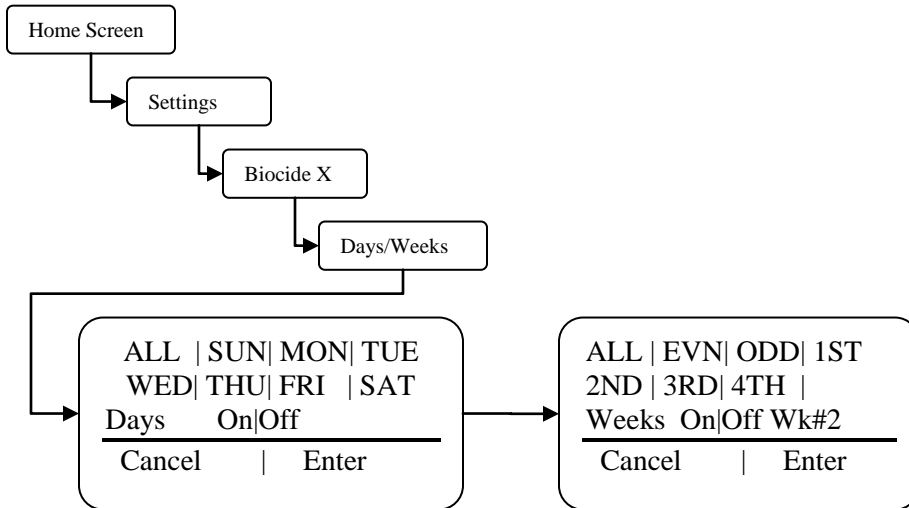

- Select the biocide start days and weeks by using the up and down buttons to the right of the display. Move the cursor to the right or left by using the button to the bottom of the display. The selected day or week will flash as the cursor is moved to each setting. The flashing On|Off text indicates if the current setting is on or off.
- If a day or week is highlighted, or appears as reverse video, that particular day or week will have biocide feed.
- The week # shown in the lower right of the display indicates which week number the controller's time is currently set to.

8. Probe Calibration

Because there are no metal electrodes to foul no re-calibration is required of this toroidal probe on a regular basis. However, you may want to calibrate the probe initially to get a base-line reading for future reference.

There are two methods of probe calibration that can be used to calibrate this probe.

- **In-stream Calibration** – In this method the probe is already installed in the process flow and is currently reading conductivity. Be certain adequate flow (1 gallon/minute minimum) has been circulating around the probe for at least 15 minutes. This will ensure the probe temperature has stabilized and a more accurate conductivity reading will be made.

Step 1 – Move to the Probe Calibration screen.

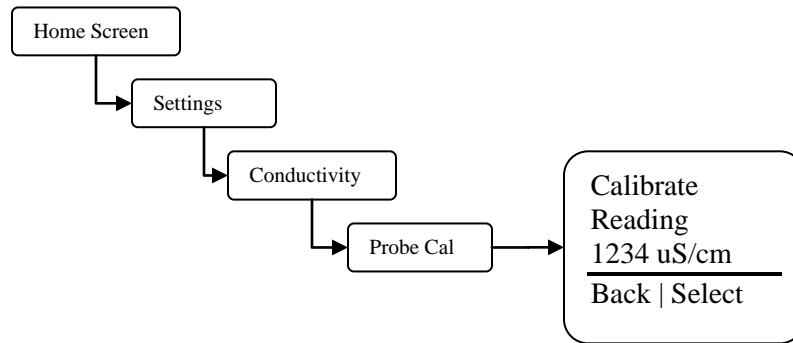

Step 2 – Draw a sample of the process flow water and measure the conductivity using a calibrated meter. Be certain the meter you are using to measure conductivity is temperature compensated. Write down the conductivity value and sample temperature.

Conductivity _____ uS/cm Sample Temperature _____ ° C



Do not allow the sample to sit for any length of time after being drawn as this will cause the temperature of the sample to be different from the probe.

Step 3 – Enter the calibrated conductivity value into the Probe Calibration screen.



If the conductivity reading varies more than 25 counts from the reading of the calibration meter verify the sample temperature is within $\pm 1^\circ$ C of the probe temperature.

Step 4 – Return to the Home Screen and verify the proper conductivity reading is displayed.

- **Standard Solution Calibration** – This calibration technique is typically used when the probe is removed from the process flow or prior to probe installation. Use a standard solution that is near the conductivity setpoint you plan on setting the controller to.

Step 1 – Pour enough standard solution into a non-metallic container so the round end of the toroidal probe is fully covered. Swirl the probe in the solution making sure there are no bubbles trapped in the center hole of the probe.



Do not set the container and probe on a metallic surface or near an electric motor or other source of strong electrical field.

Step 2 – Allow the probe to rest in the standard solution for about 15 minutes. This is needed to allow the probe to assume the temperature of the standard solution.

Conductivity _____ uS/cm Probe Temperature _____ ° C

Step 3 – Enter the standard solution conductivity value into the Probe Calibration screen.

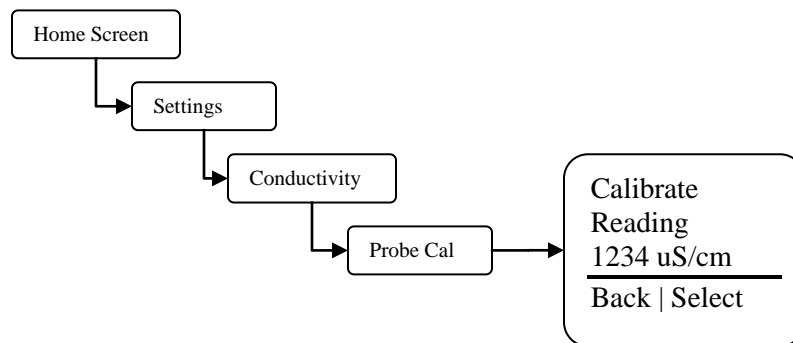

Step 4 – Return to the Home Screen and verify the proper conductivity reading is displayed.

9. Factory Defaults

Parameter	Default
Configuration	
• Date Format	MM/DD/YY
• Time Format	12hr Clock
• Water Meter Type	Dry Contact
• Water Meter Pulse Volume	100
• Water Meter Units	Gallons
• Drum Levels	Pumps Run
• Display Dampener	1 Second
• Rise/Fall Setpoint	Rising
• Display Contrast	26
• Password	0000(disabled)
• Language	English
Settings	
• Conductivity Setpoint	1500
• Conductivity Differential	50
• Conductivity Limit Timer	00:00(disabled)
• Alarm Setpoint	Track Setpoint/200us
• 4-20ma Low Range	0
• 4-20ma High Range	9999
• Inhibitor Feed Mode	Limit Timer
• Inhibitor Limit Timer	1-hour, 30-minutes
• Inhibitor Biocide Tracking	None
• Biocide A and B Days/Weeks	All Days/All weeks
• Biocide A and B Start Times	00:00(disabled)
• Biocide A and B Feed Time	1-minute
• Biocide A and B Pre-Bleed Time	00:00(disabled)
• Biocide A and B Pre-Bleed Conductivity Minimum	1475
• Biocide A and B Bleed Lockout	00:00(disabled)

10. TROUBLESHOOTING GUIDE

Symptom	Probable Cause	Possible Solution
Controller does not power up.	No power supplied to controller.	Insure that correct voltage is supplied to controller.
		Check circuit breaker supplying power to the controller.
	Fuse is blown.	check/replace fuses F1-F3 (<i>see Figure F6, Page 12</i>)
Controller displays "No Flow" alarm message.	Ribbon cable.	Check ribbon cable connecting upper and lower pc boards inside controller.
	No flow thru flow assembly.	Insure there is enough water flow through the assembly. At least 1 GPM (3.8 LPM) of flow.
	Flow switch wiring or connector loose.	Check flow switch connections (<i>see Figure F7, Page 13</i>).
	Flow switch stuck.	Clean flow switch sensor mechanicals.
	Flow assembly clogged.	Clean inside flow assembly.
Controller displays "Cond Low" alarm message.	Flow switch input jumper missing.	Install jumper if flow switch is not used.
	Conductivity reading below programmed low limit.	Adjust conductivity low limit setting (<i>See Page 25</i>).
	Excessive amount of air in and around conductivity probe.	Prime flow assembly.
Controller displays "Cond High" alarm message.	Bleed valve stuck open.	Replace/clean bleed valve.
	Conductivity reading above programmed high limit.	Adjust conductivity high limit setting (<i>See Page 25</i>).
	Excessive amount of solids and/or debris in and around conductivity probe.	Clean flow assembly.
	Faulty bleed valve.	Replace bleed valve.
Controller displays "Inhib Low" alarm message.	Clogged bleed valve or drain.	Clean valve or drain.
	Inhibitor drum fluid level low.	Refill drum.
	Drum level switch wiring or connector loose.	Check switch connections (<i>See Figure F7, Page 13</i>).
Controller displays "Bio A Low" alarm message.	Drum level switch stuck.	Clean switch sensor mechanicals.
	Biocide A drum fluid level low.	Refill drum.
Controller displays "Bio B Low" alarm message.	Drum level switch wiring or connector loose.	Check switch connections (<i>See Figure F7, Page 13</i>).
	Drum level switch stuck.	Clean switch sensor mechanicals.
Controller displays "Bio B Low" alarm message.	Biocide B drum fluid level low.	Refill drum.
	Drum level switch wiring or connector loose.	Check switch connections (<i>See Figure F7, Page 13</i>).

	Drum level switch stuck.	Clean switch sensor mechanicals.
Controller displays "Inhib Limit" alarm message.	Programmed inhibitor feed limit timer set too short.	Adjust limit timer value to longer duration (<i>See Page 26</i>).
	Clogged bleed valve or drain.	Clean valve or drain.
	Faulty bleed valve.	Replace bleed valve.
Controller displays "Probe Temp" alarm message.	Probe temperature too high.	Allow process water to cool.
	Probe temperature compensation circuitry failure.	Replace probe.
Controller displays "Probe Comm" alarm message.	Conductivity probe wiring or connector loose.	Check probe connections (<i>See Figure F7, Page 13</i>).
	Bad Conductivity probe	Replace probe.
Controller displays "Clock Err" alarm message.	Internal controller clock failure.	Replace controller.
Controller displays "Bleed Limit" alarm message.	Conductivity Limit timer set too short.	Adjust limit timer.
	Bleed valve/drain failure.	Clear obstruction around drain.
Controller displays "Watchdog" alarm message.	Internal controller failure.	Replace controller.
Conductivity reading on controller does not match portable hand-held reading.	Conductivity reading is within specification.	Due to variations in hand-held meters, conductivity standard solutions, temperature compensation, and the controller's accuracy of +/- 2% of scale, the reading on the controller may not match that of your hand-held tester exactly.

11. MAINTENANCE

The only recommended maintenance required on your controller is periodic inspection of the conductivity sensor every 6 months. It is recommended that you establish a regular maintenance schedule designed to meet the needs of your particular application. All other service should be performed by factory authorized personnel only. Modifications to or tampering with the circuit level components makes all warranties, written or implied, and/or manufacturer's responsibility for this controller, null and void.



DISCONNECT POWER BEFORE OPENING THE UNIT TO ACCESS FUSES. MAKE SURE THAT REPLACEMENT FUSES ARE OF SAME TYPE TO MAINTAIN SAFETY APPROVALS.

FUSE ⁶	TYPE
F1 & F2	5A, IEC 60127-2 · 250 VAC · Time-Lag T
F3 ⁷	1A, 2AG, Time Lag, 250VAC

12. SPECIFICATIONS

Controller	
Enclosure	NEMA 4X/ Designed to meet IP65
Enclosure Dimensions	6.4" x 3.2" x 3.2" (163 x 82 x 82mm)
Power supply	120 or 220 VAC; 50/60Hz.
Display	LCD 0 - 9,999 μ S/cm range 1 μ S/cm resolution
Accuracy	+/- 2% of scale
Maximum relay output current	120 VAC: <ul style="list-style-type: none"> • 5 A Resistive/General use • 4LRA/4FLA, 1/10HP (motors) 220 VAC: <ul style="list-style-type: none"> • 5 A Resistive/General use • Not rated for motors

⁶ All fuses are UL, CSA recognized or listed.

⁷ F3 is not serviceable in the field.

Probe	
Maximum temperature	122° F (50°C)
Temperature compensation range	32°F – 122°F (0° – 50°C)
Maximum pressure	125 PSI (8,6 BAR)
Probe type	Toroidal
Maximum cable length	100 Feet (30,5 Meters)
Materials of construction	Polypropylene
Thread size	½" Standard thread -Excludes Tee and Reducer
Maximum outside diameter	1.5" (38 mm)- Excludes Tee and Reducer
Conductivity reading	0-9999 uS/cm; 1 uS/cm increments

Flow Switch	
Maximum temperature	127°F (52°C)
Maximum pressure	125 PSI (8,6 BAR)
Activate flow rate	Approximately 1 GPM (3,785 LPM)
Materials of construction	PVC and Glass filled Polypropylene

13. GLOSSARY

- Alarm Relay** – an electric circuit when triggered by a predetermined signal will activate an externally connected alarm
- Analog** – a continuous signal (4-20mA) that can be used to represent a physical variable, e.g., conductivity
- Biocide** – an agent used to control the growth of algae and other organic substances
- Bleed** – to release water from the system, used to control conductivity
- Bleed Valve** – the valve that opens or closes to release water from the system activated by a signal from the Controller
- Buffer Solution** – a solution with a specific pH value used as a control in calibrating probes.
- Calibration** – a procedure to match values “read” by probes to actual real world values
- Chattering** – a situation that occurs when relay controlled device repeatedly turns off and on
- Chemical Feed Pump** – a relay or proportionally controlled pump that disperses chemical into the system (e.g., PULSAtron)
- Chemical Metering Pump** – see Chemical Feed Pump
- Conductivity** – the ability of a substance to conduct electrical current, concentrations of dissolved and suspended solids in water directly determine the conductivity of the water
- Conduit** – tubing through which wire is run
- Configure** – procedure to setup basic functions of the controller, i.e., date, time, set point control, etc.
- Contacting head water meter** – a water meter that outputs a dry contact signal every time it pulses
- Contrast** – difference in brightness between adjacent objects, e.g., darkness of text in screen display verses background
- Cooling Tower** – a structure of various sizes that allows heat to radiate away from the system water
- Cursor** – See prompt
- Cycle Timer** – a timing device that can be preset to turn off and on at specific intervals
- Differential** – also referred to as dead band or hysteresis, this is a range or offset applied to a set point value (see chattering)
- Dry Contact** – relay contacts without power
- Electrodes** – or probes, the metal protrusions that measure conductivity in the conductivity probe assembly
- Float Switch** – a mechanical switch that provides an electrical contact when the water level rises to a predetermined height
- Flow** – refers to the movement of water through the system
- Flow Assembly** – an option, which attaches to the controller and incorporates a flow switch, probe/probe ports, and sample valve
- Hall Effect Water Meter** – Solid state flow detection device
- Heat Exchanger** – a mechanical device that facilitates the transfer of heat between two mediums
- High Current** – 20 mA signal
- Hi Lo Alarm** – a function of the controller that signals the user when conditions exceed a predetermined high or low value
- HOA** – abbreviation for Hands-Off-Auto relay control
- Inhibitor** – a chemical or compound used to aid the control of corrosion or scaling in the cooling tower system
- Inhibitor Feed** – term referring to the disbursement of inhibitor in to the system
- Inhibitor Timer** – a function of the controller that regulates the amount of time inhibitor is introduced to the system
- Initialization** – a procedure to reset the controller to original factory conditions
- Inorganic Scale Deposits** – undesirable precipitate formations within the cooling tower system

Inputs – receptacles or hook-ups for signals delivered to the controller

Interval – the amount of time between bleed events

Isolated Input – an input (analog or digital) that is electrically isolated from main power supply and its ground

(ISO) Isolation Valves – general term that refers to valves in the system used to isolate various components of the system from the main flow

Jumper – a wire connector (shunt) that connects two (2) points

LED – abbreviation for Light Emitting Diode

Limit Timer – also referred to as lockout timer or feed limit timer, it limits the amount of time output is activated

Line Voltage – voltage equivalent to outside source voltage to the controller

Lockout – intentionally preventing bleed or other functions of the system

Low Current – 4 mA signal

Menu Map – printed document supplied with controller illustrating all menu item locations

Metering Pump – see chemical feed pump

Micro Siemens – unit of measure of conductivity expressed as $\mu\text{S}/\text{CM}$

Outputs – receptacles or hook-ups for signals originated at the controller

Overfeed – a condition in which the quantity of an ingredient dispersed into the system exceeds the amount desired

Percent Post Bleed – refers to the amount of time as a percentage of bleed time that chemical feed pumps are activated when bleed down is deactivated

Percent Timer – also referred to as a cycle timer that runs continuously that activates an output to run as a percent of total cycle time

Pre Bleed – refers to the time bleed is executed before biocide feed

Program Parameters – the user programmed settings that determine how the controller responds to conditions of the system under control

Prompt – a cursor used to indicate the active menu line

Pulse – the action of a water meter that when equipped with a contact head, can generate a dry contact closure that can be read by the controller

Pulse Timer – a feature of the controller in which a timer accepts pulses from a water meter to actuate a chemical feed pump

Relay Indicators – lights (LED's) located on the face of the control panel that indicate the status of individual relays

Sample – to obtain a quantity of water for test purposes,

Sample Cock – see Sample Valve

Sample Line – a line through which a portion of the system water flows, where probes and other monitoring devices are located controlled with isolation valves

Sample Valve – small valve on the flow assembly that provides user a means to drain small quantities of water from the system for testing

Security Code – a code that can be entered by the user when configuring the system to secure access to the controller settings

Probe – a device connected to the controller which monitors or measures a characteristic value in the water, like the conductivity

Sensor – see Probe

Set point – the user determined value within a monitored range at which the controller initiates action (e.g., activates a relay)

Set point Differential – also referred to as dead band or hysteresis; the offset applied to a set point to prevent chattering of an output relay around a set point

Soft Keys – Buttons on front panel used to input information

Solenoid – an electromagnetically controlled switch

System Overfeed – usually a malfunction condition where a feed pump fails in the Run (ON) condition

System Parameters – see program parameters

TDS – abbreviation for Total Dissolved Solids, measured in terms of electrical conductivity ($\mu\text{S}/\text{CM}$)

Temperature Compensation – displays conductivity as if measured at 77°F (25°C)

Toroidal Conductivity – Non-contacting conductivity sensor used for high values

Totalizer – a re-settable function of the controller that keeps count of the number of water meter pulses

$\mu\text{S}/\text{CM}$ – conductivity unit of measure. Often referred to as micro Siemens

Y-Strainer – inline filter or screen to remove debris from system flow assembly

14. MOUNTING HOLE PATTERN (Footprint)

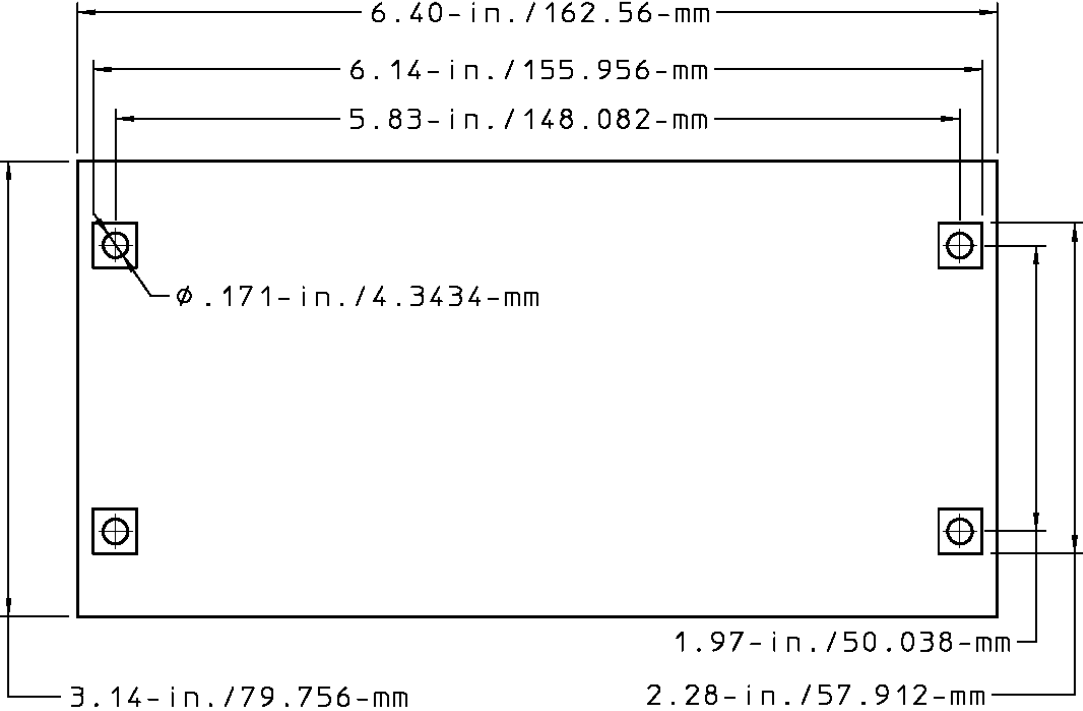

Fig. 9

15. Factory Service Policy

Your MICROVISION is a state of the art microprocessor based controller. If you are experiencing a problem with your process control instrument, first consult the troubleshooting guide in this manual. If the problem is not covered or cannot be solved, contact Technical Services for assistance:

PULSAFEEDER INC. (SPO)
27101 AIRPORT ROAD
PUNTA GORDA, FL 33982
941-575-3800

Trained technicians are available to diagnose your problem and arrange a solution. Solutions may include purchase of replacement parts or returning the controller to the factory for inspection and repair. All returns require a Return Authorization number to be issued by Pulsafeeder. Parts purchased to correct a warranty issue may be credited after an examination of original parts by Pulsafeeder. Warranty parts returned as defective which test good will be sent back freight collect. No credit will be issued on any replacement electronic parts.

Any modifications or out-of-warranty repairs will be subject to bench fees and costs associated with replacement parts.

16. Warranty

Pulsafeeder, Inc. warrants control systems of its manufacture to be free of defects in material or workmanship. Liability under this policy extends for 24 months from date of shipment. Electrodes/probes are considered maintenance items and as such are warranted for six (6) months from the date of shipment of the controller. Electrodes/probes purchased as spare parts are warranted for 24 months from date of shipment. The manufacturer's liability is limited to repair or replacement of any failed equipment or part, which is proven defective in material or workmanship upon completion of the manufacturer's examination. This warranty does not include removal or installation costs and in no event shall the manufacturer's liability exceed the selling price of such equipment or part.

The manufacturer disclaims all liability for damage to its products through improper installation, maintenance, use, or attempts to operate such products beyond their functional capacity, intentionally or otherwise, or any unauthorized repair. The manufacturer is not responsible for consequential or other damages, injuries, or expense incurred through the use of its products.

The above warranty is in lieu of any other warranty, whether expressed or implied. The manufacturer makes no warranty of fitness or merchantability. No agent of ours is authorized to provide any warranty other than the above.



USA

Pulsafeeder, Inc.
27101 Airport Rd.
Punta Gorda, FL 33982
USA
(941) 575-3800
www.pulsa.com

European Union (EU)

PULSAFEEDER-Europe
Via Kennedy, 12-20090
Segrate—Milano— Italy